

Elevator
ALAMEX
Ascending Together

www.alam.mx

ELEVATOR SYSTEMS HOME LIFT
ROBOTIC PARKING SYSTEMS
ESCALATOR MOVING WALKWAYS
TOUCHLESS TECHNOLOGY CABINS
DOORS SPARE PARTS ACCESSORIES

2024
Catalogue

ASCENDING TOGETHER



THE ELLIES 2022

Best Supplier – Parts
Headquarters: Bloomfield,
Connecticut
Runner up: Alamex
Headquarters: Mexico City



ASCENDING TOGETHER





INDEX



04

ABOUT ALAMEX

- ▶ Why Choose Alamex
- ▶ Certificates
- ▶ International Presence

09

ELEVATOR SYSTEMS

- ▶ Alamex Elevator
 - Traction Systems
 - > MR
 - > MRL-L
 - > MRL-G
- > MRL-C
- > Hydraulic Elevators
- > Cargo Elevators - Platform Elevators

17

CABINS

- ▶ Standard Cabin
- ▶ Hospital & Freight Cabin
- ▶ Panoramic Cabin
- ▶ Ceiling Models
- ▶ Flooring Models
- ▶ Coating Models

28

DOORS

- ▶ Central 2 panel cabin doors
- ▶ Telescopic 2 panel cabin doors
- ▶ Telescopic 3 panel cabin doors
- ▶ Central 2 panel landing doors
- ▶ Telescopic 2 panel landing doors
- ▶ Telescopic 3 panel landing doors
- ▶ Swing Doors - Guillotine Door

36

CONTROL SYSTEMS

40

HOME LIFT

- ▶ Platform Elevator
- ▶ Duplex Villas Elevator
- ▶ Enclosed Type Platform
- ▶ Open Type Disabled Platform
- ▶ Service Elevator

54

ROBOTIC PARKING SYSTEMS

- ▶ Car Lift Platform
- ▶ Car Stack
- ▶ Automated Parking System

58

ESCALATOR & MOVING WALKWAYS

- ▶ Moving Walkways
- ▶ Escalators

61

TOUCHLESS TECHNOLOGY

64

SPARE PARTS & ACCESSORIES

- ▶ Traction Machines
- ▶ Elevator Buttons
- ▶ Spare Parts

68

TECHNICAL SHEETS



ABOUT ALAMEX

We are a young and dynamic company, we began operations in Latin America in 2011, with more than 20 years of experience. At Alamex, we design top-quality lifting solutions with cutting-edge innovations.

Alamex is a company specialized in designing, developing, manufacturing, distributing, installing, and maintaining high-tech lifting solutions. We produce all types of elevator systems including passenger elevators, home elevators, platform elevators, dumbwaiters, construction elevators, cargo elevators, and more.

We have exports to more than 55 countries in Europe, North America, South America, Africa, Asia & Australia.

All our products are manufactured in accordance with the latest European Standards for Safety and Quality, which guarantees high durability with minimal maintenance.



Elevator Systems

- Passenger Elevator
- Home Elevator
- Platform Elevator
- Service Elevator (Dumbwaiter)
- Cargo Elevator



Parking Systems

- Car Lift Platform
- Car Stack
- Automated Parking Systems



Escalators & Moving Walkways

- Escalators
- Moving Walkways



20
YEARS
OF EXPERIENCE



WHY CHOOSE US



Lifting solutions from conceptualization and design to specify the installation and maintenance.



National and international certifications of compliance with the latest safety and quality standard.



Customer support in 6 languages



INTERNATIONAL PRESENCE



Thanks to our professional team, we could improve our product quality and develop new technologies to the extend that we became internationally well-known for our unique products and services.

Our exports extends internationally, currently to more than 55 countries in 5 continents around the world.

We also provide customer support in 6 languages.



Barbados
Canada
Costa Rica
Guatemala
Mexico
Netherlands
Panama
The Salvador
USA

Colombia
Paraguay

Algeria
Egypt
Ethiopia
Kenya
Libya
Mauritania
Morocco
Mozambique
Tunisia
Zanzibar

Belarus
Danimark
Greece
Georgia
Italy
Romania
Slovakia
Ukraine

Armenia
Bahrain
Dubai
Azerbaijan
Iraq
Jordan
Kazakhstan
Kuwait
Lebanon
Oman
Palestine
Philippines
Russia
Qatar
Saudi Arabia
Syria
Turkmenistan
UAE

Australia



Elevator

ALAMEX

Ascending Together

QUALITY AND SAFETY IN
ELEVATOR SYSTEMS
PRODUCTION



alamexelevator    

ALAMEX ELEVATOR

Since its foundation, Alamex's main policy is to provide the best quality lifting systems and all products are manufactured in accordance with the latest European Standards for Quality and Safety, which guarantees high quality and durability with minimal maintenance.



High quality products with warranty againsts manufacturing defects up to 5 years



Reduction in installation time and cost.



Unique elevator design according to the required preferences.



Variety of cabin models & operation panels.



Security processes to ensure that the system is 100% secure.



Minimal need for mainainance

TRACTION ELEVATOR

This type of elevators, a counterweight system is used, achieving a highly efficient lifting process. It is used with medium and high speed equipment, the use of a counterweight helps to reduce the weight that the tractor unit must drag, thus reducing the power required to raise the cabin.

According to their functionality and structure, they are classified as follows:

- MR • MRL-L • MRL-G
- Hydraulic Elevator
- Hydraulic Cargo Elevator
- Hydraulic Platform Elevator
- Enclosed Elevator System
- Cabin - Telescopic closed platform
- Open Platform Lift
- Service Elevator

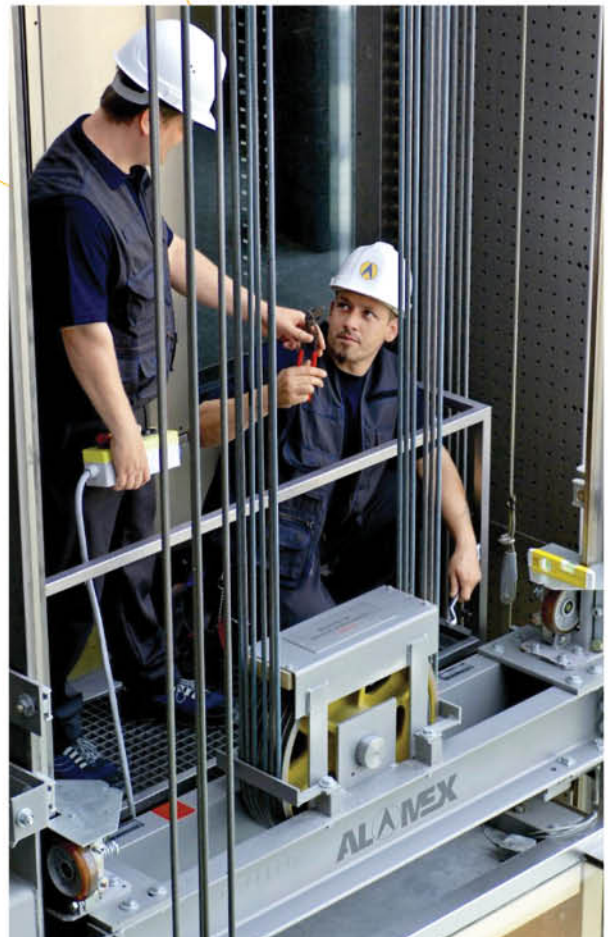

TRACTION ELEVATOR - MR

The Machine-Room (MR) traction elevator has a machine room above the hoistway, so that the machinery and the equipments are in a separate space from the bucket, making its maintenance much easier.

If we divided the spaces necessary for the installation of an elevator into parts, we could group them into three main parts:

Machine Room

It is one of the most important areas, as it contains the control panel, the traction machine and the speed regulator.

Overhead

The area from the top of the upper finished floor to the nearest overhead obstruction within the shaft.

Pit

The depression below the surface of the lowest landing that allows the elevator floor to be level with the floor of the lowest landing.



TRACTION **ELEVATOR - MRL- L**

This system has important advantages from an architectural point of view, since we can avoid the classic machine room and thus obtain a better use of the spaces at the time of installation and thus save it for other purposes.

The traction machine is located inside the cube, while the control is installed on a panel located on the last upper level, next to the elevator door.

MRL-L: Cabin chassis model



TRACTION ELEVATOR - MRL-G

It features a compact, quiet, gearless, and highly energy efficient permanent magnet technology machine. The reduced weight and the flexibility of the system make it possible to use a more compact machine that optimizes the occupation of space with a more efficient engine, without oil replacement, with minimum need for maintenance and therefore more ecologically advantageous.

MRL-G: Cabin chassis model G.

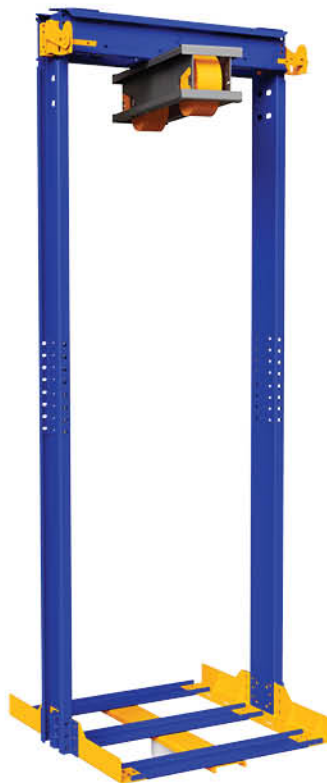
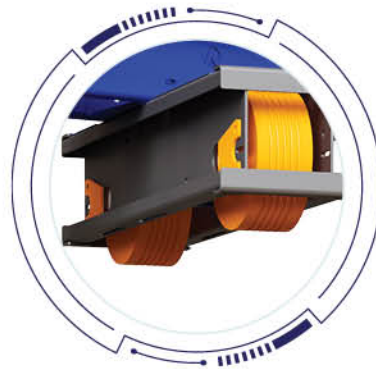
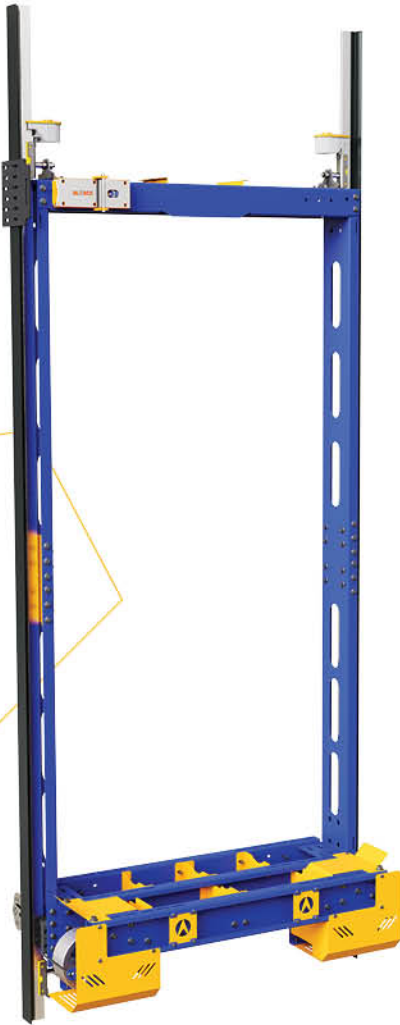

TRACTION **ELEVATOR - MRL-C**

Introducing MRL-C, a groundbreaking elevator innovation. With just a minimum of 200 mm pit and 3500 mm overhead requirements, this system minimizes chassis size, reducing consumable chassis size while providing a more spacious cabin within the shaft. Available in Slim and Normal variants according to the technical need, MRL-C redefines convenience with easy assembly, setting a new standard in elevator technology and streamlining the installation process for enhanced convenience.



HYDRAULIC ELEVATOR

The increase in demand in the European market during the last decade, in combination with the flexibility of the new European regulations, guided Alamex towards the design, certification and supply of hydraulic lifts.

The power module is the most comfortable option from an architectural point of view, since it can be located in the lower or basement part of the building.



Travel from 12 to 15 meters.



Smooth and quiet operation.
Easily adapts to tight spaces.



In the event of a power outage, it has an alternative system that allows reaching the closest level, allowing the safe exit of passengers.



Energy consumption only when rising.
On the way down, it uses gravity without the need to consume.



low-cost installation and maintenance prices.
Fewer number of components.



HYDRAULIC CARGO ELEVATOR

It is suitable for use in industrial facilities and warehouses. The flexibility in dimensions and capacities make it adaptable for any special requirement.

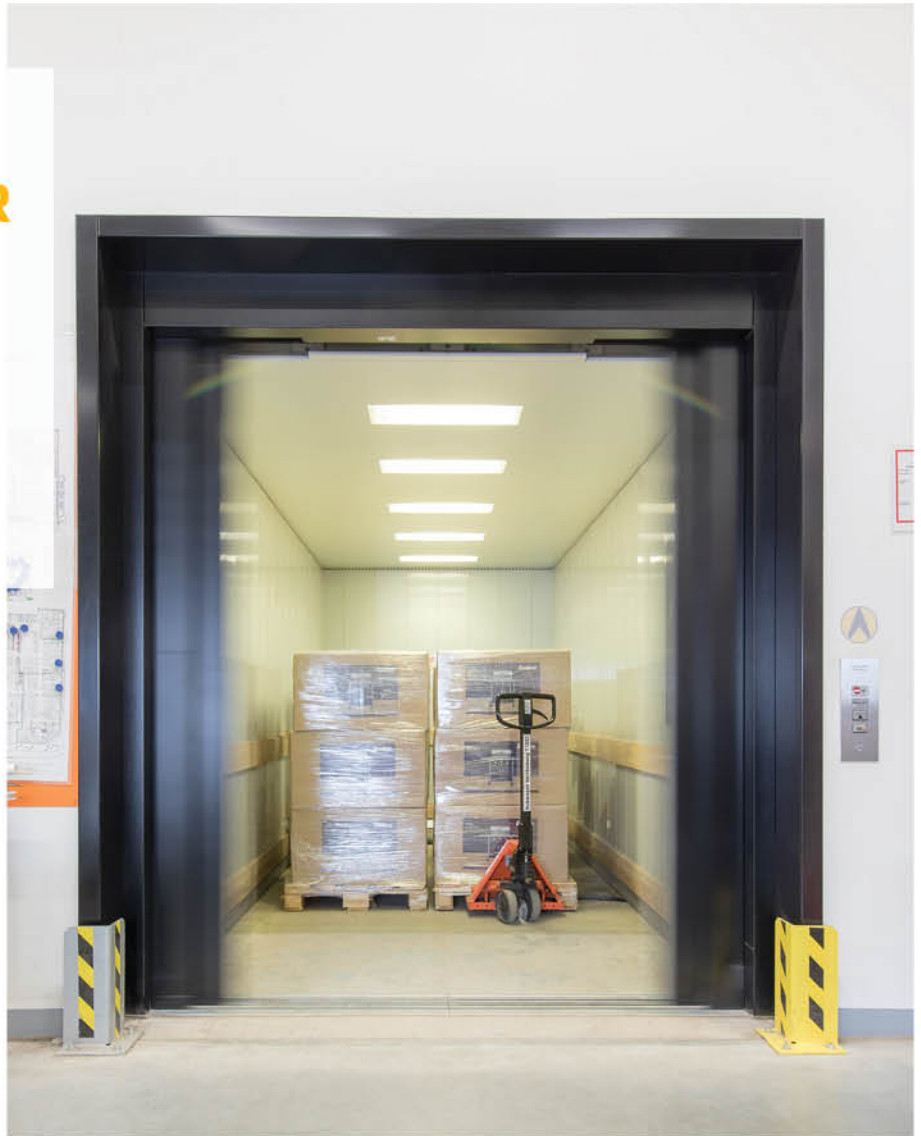

Manufactured in accordance with machinery directive 2006/42 / EC and EN-81.



Pre-assembled in rigid steel structure.



Available with platform, half cab, or full cab.



Minimum requirements in bucket depth and machine room.



Capacity from 200 to 5,000 Kg.



Maximum speed of 0.6 m / s



CABIN MODELS



ASCENDING
TOGETHER



CLX-S 201



CLX-S 101



CLX-S 301



CLX-G 101





CLX-G 201



CLX-G 401



CLX-L 101



CLX-M 101



**HOSPITAL &
FREIGHT CABIN**



Hospital
Cabin



CLX-Y
101



PROPERTIES

- 1.5 mm sheet metal cabin wall.
- AISI 304 quality stainless steel.
- Both internal & external stainless steel coating.
- All parts are laser cut.
- Easy assembly structure.
- Technical bends for extra strength.
- Various floor & ceiling options.
- Designed and manufactured on request in
- Accordance with the application needs.

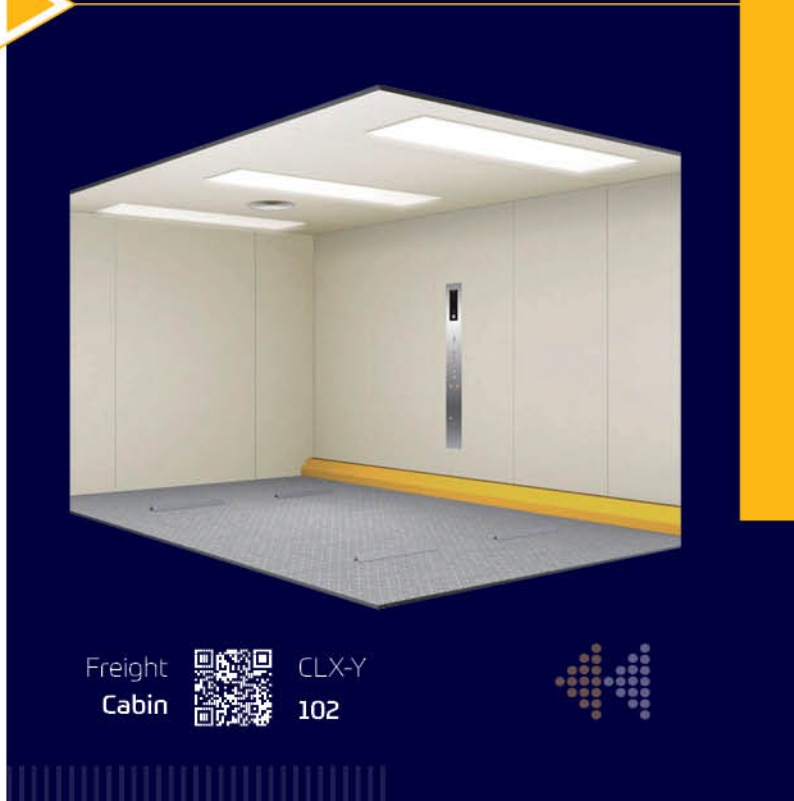

Freight
Cabin



CLX-Y
102





PANORAMIC CABIN



Square
Panoramic
Cabin



CLX-P
101



Round
Panoramic
Cabin



CLX-P
102

PROPERTIES

- 1.5 mm sheet metal cabin wall.
- AISI 304 quality stainless steel.
- Both internal & external stainless steel coating.
- All parts are laser cut.
- Easy assembly structure.
- Technical bends for extra strength.
- Car in stainless steel with curved or straight glass panoramic rear wall.



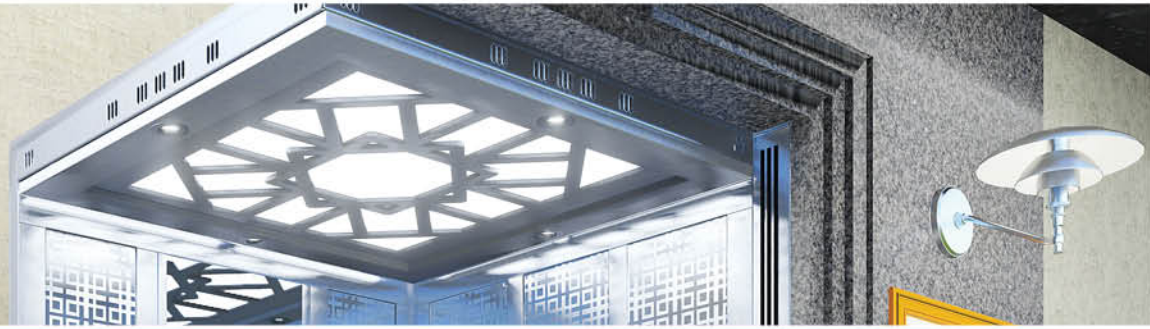

LV-01

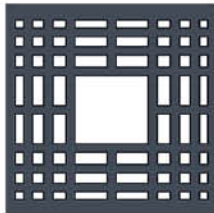

LV-02

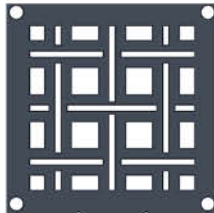

LV-03

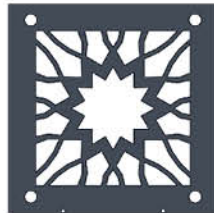

LV-04



LV-05



LV-06



LV-07



LV-08

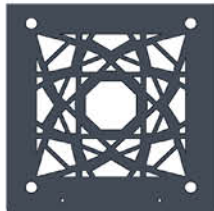

LV-09



LV-10

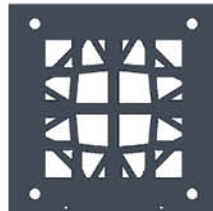

LV-11



LV-12

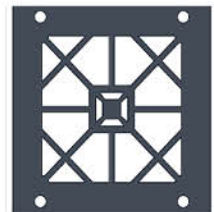

LV-13

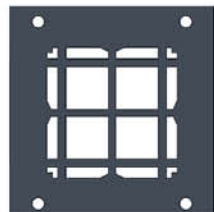

LV-14



LV-15



LV-16

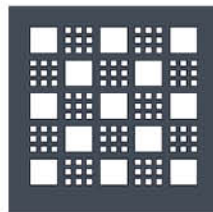

LV-17

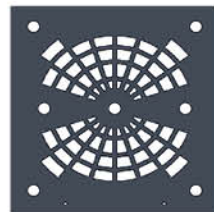

LV-18

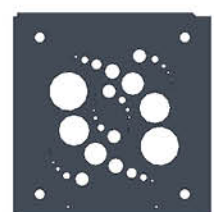

LV-19



LV-20

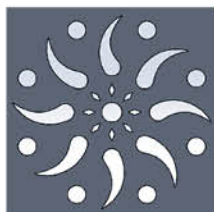

LV-21

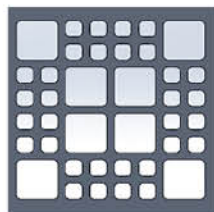

LV-22



LV-23

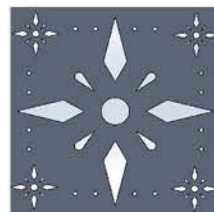

LV-24



LV-25



LV-26



LV-27

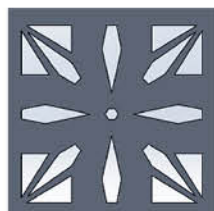

LV-28



LV-29



LV-30



LV-31



LV-32

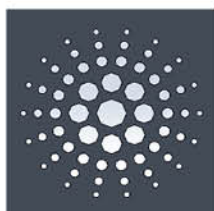

LV-33

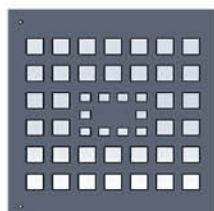

LV-34



LV-35



LV-36

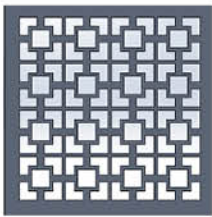

LV-37



LV-38



LV-39

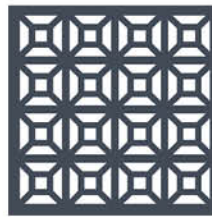

LV-40



LV-41



LV-42



LV-43



LV-44

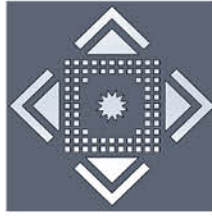

LV-45

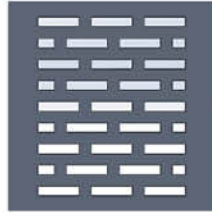

LV-46

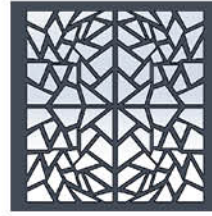

LV-47



LV-48



LV-49

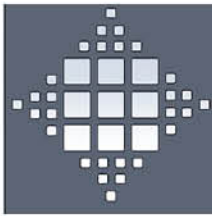

LV-50



LV-51



LV-52



LV-53



LV-54



LV-55

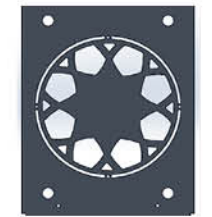

LV-56

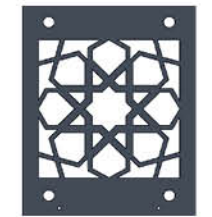

LV-57

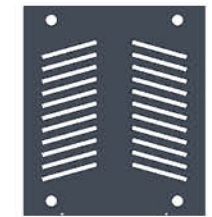

LV-58



LV-59

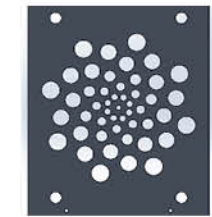

LV-60



LV-61

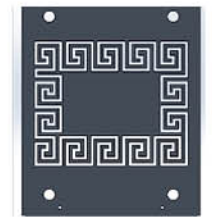

LV-62

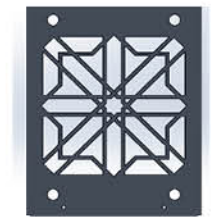

LV-63



LV-64



LV-65



LV-66

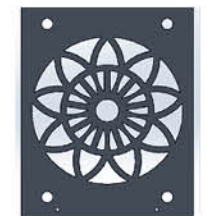

LV-67

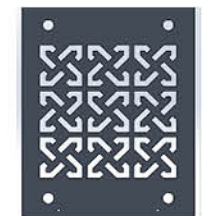

LV-68



LV-69



LV-70

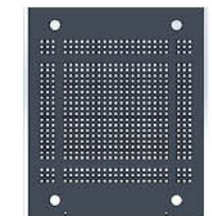

LV-71

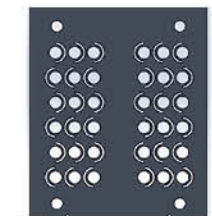

LV-72

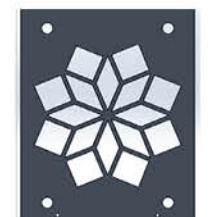

LV-73

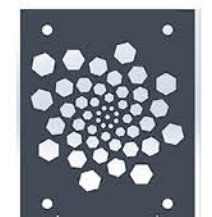

LV-74

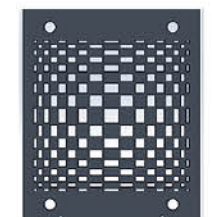

LV-75



LV-76

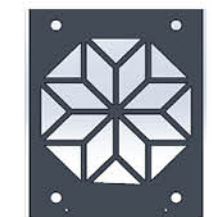

LV-77

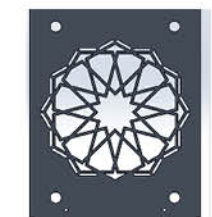

LV-78



Granite Flooring Models | PVC Flooring Model

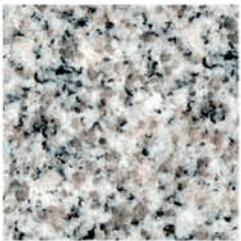

Bianco Perla

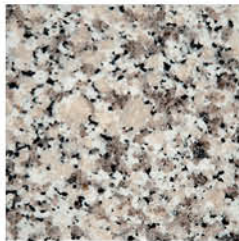

Bianco Sardo

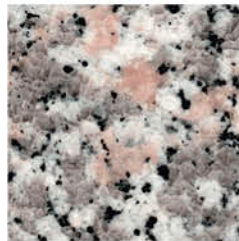

Rosa Beta

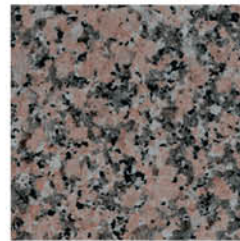

Rosa Porino

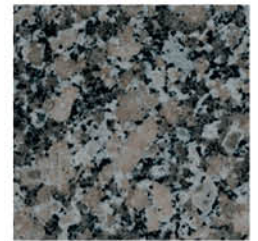

Rosa Minho



African Red



Multi-color Red



Melisa



Sofita Bej



Tan Brown



Star Galaxy



Nero Zimbabwe



African Lilac



Giallo Fiorito



Giallo Cecilia

PVC

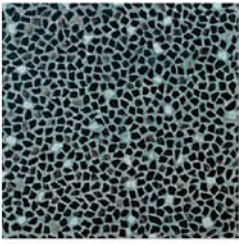

ALX-FP 01



ALX-FP 02



ALX-FP 03



ALX-FP 04



ALX-FP 05



ALX-FP 06



ALX-FP 07



ALX-FP 08



ALX-FP 09



ALX-FP 10

Tempered Glass



ALX-FG 01



ALX-FG 02



ALX-FP 03



ALX-FP 04



ALX-FP 05

Special Ceramic



ALX-FC 01



ALX-FC 02



ALX-FC 03



ALX-FC 04



ALX-FC 05

Checkedered Flooring Models

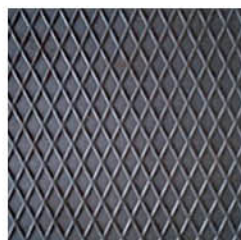

Checkedered Stainless Sheet

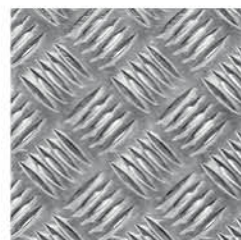

Certified Aluminum



For more visit our website



GOLD C101

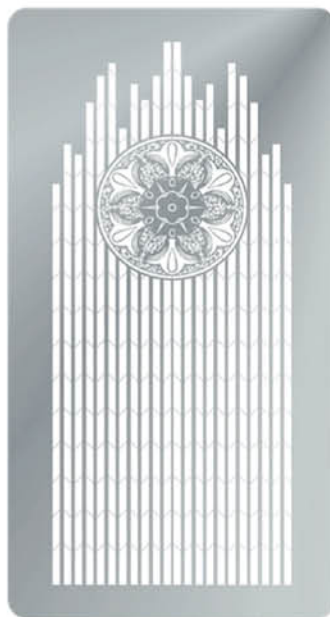

SILVER C102

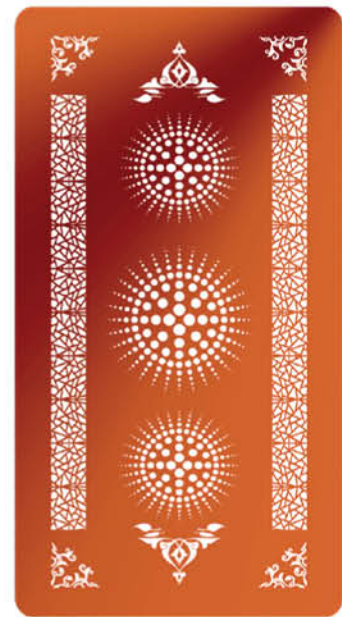

COPPER C103

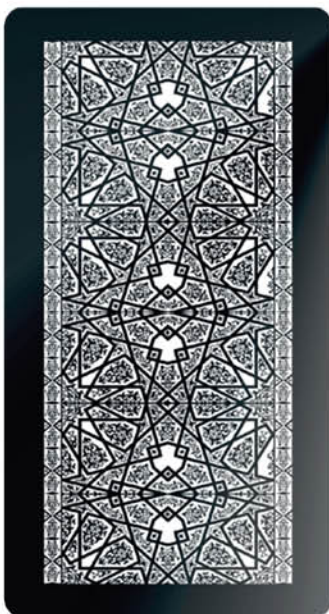

BLACK C104



GOLD C106



SILVER C107



For more visit our website



COPPER C108

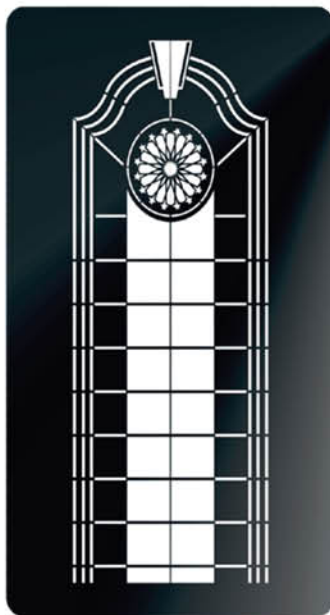

BLACK C109



GOLD C111



SILVER C112



COPPER C113



BLACK C114

ELEVATOR
DOORS



ASCENDING
TOGETHER

CENTRAL 2 PANELS CABIN DOOR

Technical Drawings

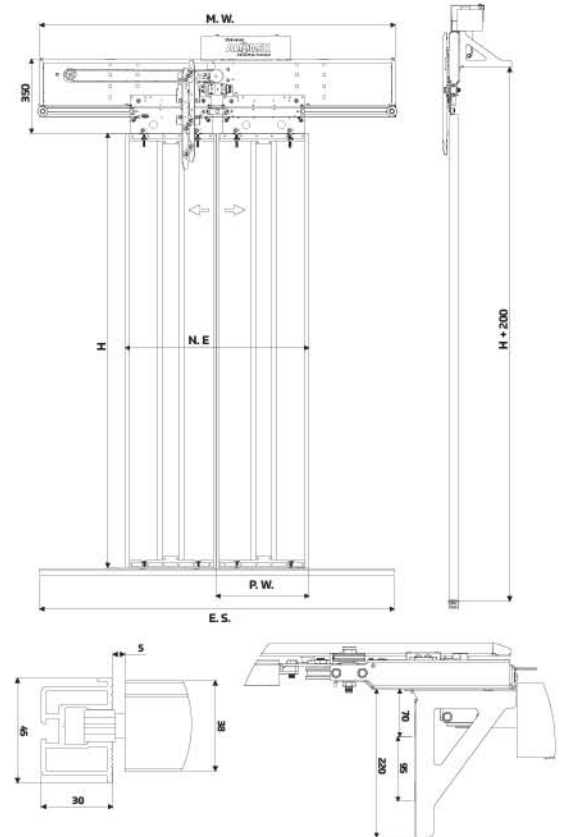

TECHNICAL SPECIFICATIONS

- Modular installation.
- Panels adjustment in three axes
- Glass framed panel options for modern designs
- Entry width adjustment
- 220 V AC and 115 V AC Supply Voltage
- Dual Channel 100 Pulse Encoder
- Driver Options;
- 24 V DC motors and drivers (with reductor)
- 220 V AC motors and drivers (without reductor)

Series	Type	Cabin Doors	Entry Width		Entry Height	
			Min.	Max.	Min.	Max.
A1-1	A2P		700	1600	*2000	*2300

*Dimensions (mm) | *Note : Standard 2000 mm

Technical Dimensions

	700	800	900	1000	1100	1200	1300	1400	1500	1600
N.E	700	800	900	1000	1100	1200	1300	1400	1500	1600
M.W	1450	1650	1850	2050	2250	2450	2650	2850	3050	3250
P.W	380	430	480	530	580	630	680	730	780	830
E.S	1400	1600	1800	2000	2200	2400	2600	2800	3000	3200

H = Min. 2020 mm / Max. 2320 mm

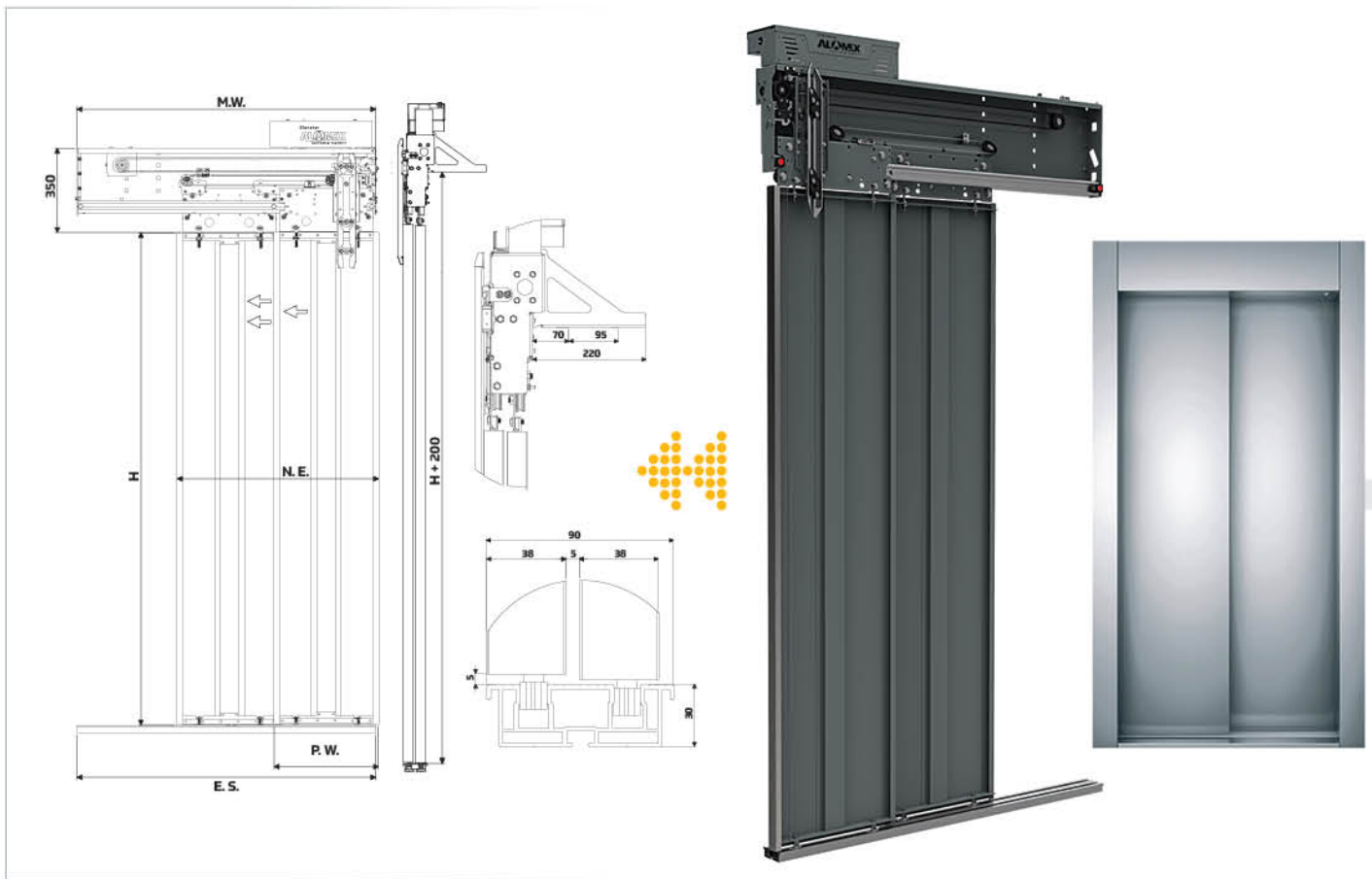

TECHNICAL SPECIFICATIONS

- Modular installation
- Panels adjustment in three axes
- Glass framed panel options for modern designs
- Entry width adjustment
- 220 V AC and 115 V AC Supply Voltage
- Dual Channel 100 Pulse Encoder
- Driver Options;
- 24 V DC motors and drivers (with reductor)
- 220 V AC motors and drivers (without reductor)

Series	Type	Cabin Doors	Entry Widht		Entry Height	
			Min.	Max.	Min.	Max.
A2-1	T2P-L		700	1600	*2000	*2300
	T2P-R		700	1600	*2000	*2300

*Dimensions (mm) | *Note : Standard 2000 mm



Technical Dimensions

N.E	700	800	900	1000	1100	1200	1300	1400	1500	1600
M.W	1070	1220	1370	1520	1670	1820	1970	2120	2270	2420
P.W	380	430	480	530	580	630	680	730	780	830
E.S	1050	1200	1350	1500	1650	1800	1950	2100	2250	2400

H = Min. 2020 mm / Max. 2320 mm

TELESCOPIC 3 PANELS CABIN DOOR

 *Technical Drawings*

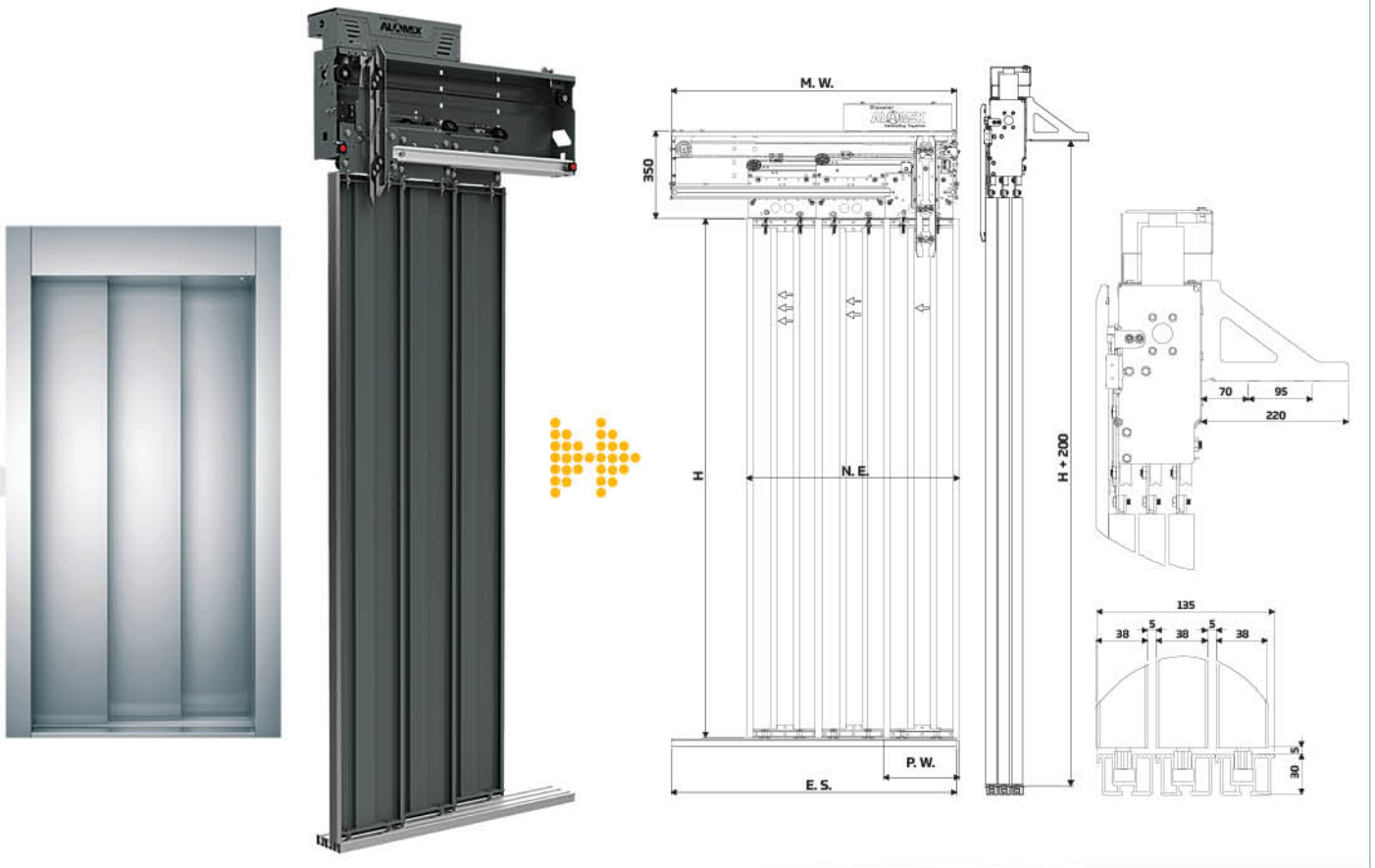

TECHNICAL SPECIFICATIONS

- Modular installation
- Panels adjustment in three axes
- Glass framed panel options for modern designs
- Entry width adjustment
- 220 V AC and 115 V AC Supply Voltage
- Dual Channel 100 Pulse Encoder
- Driver Options;
- 24 V DC motors and drivers (with reductor)
- 220 V AC motors and drivers (without reductor)

Series	Type	Cabin Doors	Entry Width		Entry Height	
			Min.	Max.	Min.	Max.
A3-1	T3P-L		700	1600	*2000	*2300
	T3P-R					

*Dimensions (mm) | *Note : Standard 2000 mm

Technical Dimensions

	N.E	700	800	900	1000	1100	1200	1300	1400	1500	1600
M.W		183,3	1117	1250	1383	1517	1650	1783	1917	2050	2183
P.W		263,3	296,7	33,	363,3	396,7	430	460,3	496,7	530	563,3
E.S		943,3	1077	1210	1343	1477	1610	1743	1877	2010	2143

H = Min. 2020 mm / Max. 2320 mm

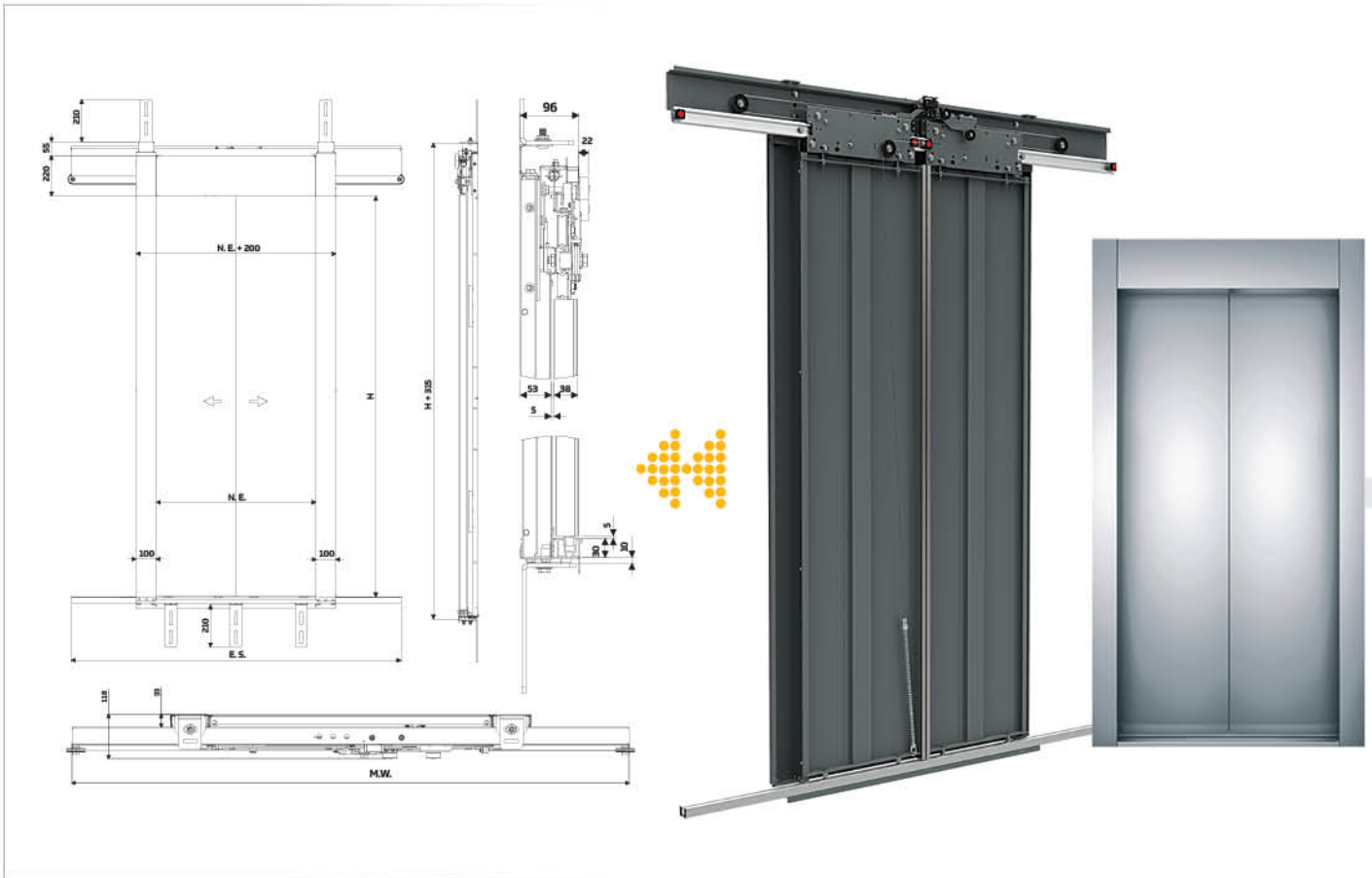

TECHNICAL SPECIFICATIONS

- CE Locking System
- Modular Installation
- Easy Installation with Reference Marks
- Mechanism Position Adjustment
- Panel Adjustment in Three Axes
- Adjustment of the Lock System
- Spring Hardness Adjustment
- Panel Options for Modern Designs
- According to EN 81-58; - E60

Series	Type	Cabin Doors	Entry Width		Entry Height	
			Min.	Max.	Min.	Max.
A-1	M2P		700	1600	*2000	*2300

*Dimensions (mm) | *Note : Standard 2000 mm



Technical Dimensions

N.E	700	800	900	1000	1100	1200	1300	1400	1500	1600
M.W	1450	1650	1850	2050	2250	2450	2650	2850	3050	3250
E.S	1400	1600	1800	2000	2200	2400	2600	2800	3000	3200

H = Min. 2020 mm / Max. 2320 mm

TELESCOPIC 2 PANELS LANDING DOOR

Technical Drawings

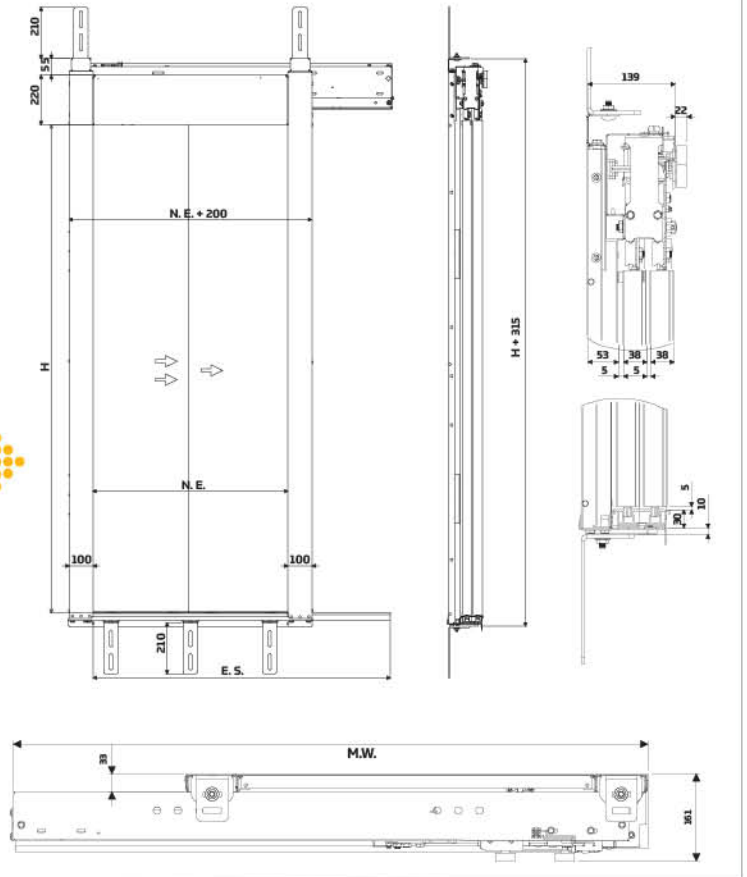

TECHNICAL SPECIFICATIONS

- CE Locking System
- Modular Installation
- Easy Installation with Reference Marks
- Mechanism Position Adjustment
- Panel Adjustment in Three Axes
- Adjustment of the Lock System
- Spring Hardness Adjustment
- Panel Options for Modern Designs
- According to EN 81-58; - E60

Series	Type	Cabin Doors	Entry Width		Entry Height	
			Min.	Max.	Min.	Max.
A2	T2P-L		700	1600	*2000	*2300
	T2P-R					

*Dimensions (mm) | *Note : Standard 2000 mm

Technical Dimensions

	700	800	900	1000	1100	1200	1300	1400	1500	1600
N.E	700	800	900	1000	1100	1200	1300	1400	1500	1600
M.W	1170	1320	1470	1620	1770	1920	2070	2220	2370	2520
E.S	1050	1200	1350	1500	1650	1800	1950	2100	2250	2400

H = Min. 2020 mm / Max. 2320 mm



ALM - 110



ALM - 120



ALM - 130



ALM - 140



ALM - 150



ALM - 160

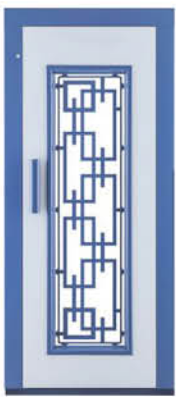

ALM - 170



ALM - 180



ALM - 190



ALM - 200



ALM - 210



ALM - 220

MANUAL DOORS

- Considered as an economic solution, both for passenger and merchandise elevators.
- The entrance varies from 800 to 4000 mm.
- Distinguished by rigid and reliable structure.
- Easy installation and maintenance.
- Wide range of paintings and finishes.

SEMI-AUTOMATIC DOORS

The semi-automatic door system is suitable for elevators with manual floor doors.

The main advantage is the small shaft it requires, distinguished by:

- Rigid structure.
- Low noise and smooth operation.
- Easy installation and maintenance.
- Thickness from 80 to 120 mm.

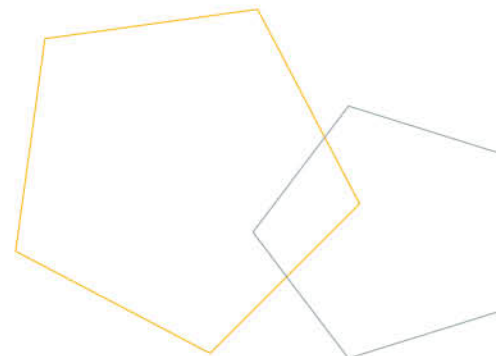



CONTROL SYSTEMS



**ASCENDING
TOGETHER**



MINI INTELLIGENT

General Specifications

- 3kW to 15kW
- Contactorless (STO) Design
- Supports up to 12 floors
- Simplex and duplex operation
- Pre-torque and anti-rollback function
- Direct landing
- Supports Open-Loop and Closed-Loop applications
- Works with geared and gearless machines
- Easy Installation
- User friendly hand terminal option

INTELLIGENT

General Specifications

- 3kW to 30kW
- AE-MAESTRO operates quietly through its contactorless system (Safe Torque Off – STO)
- In conformity with EN81-20/50, EN81-1, EN81-28, 70, 72, 73 standards
- Operates up to 64 stops
- Car serial or full-serial shaft communication
- Operation support for simplex, duplex, triplex and for group of lifts up to 8
- Distance based operation with encoder
- USB and Ethernet interfaces
- Remote access via internet
- SSI, EnDat, SinCos, BISS encoder support for synchronous motors
- Built-in RFI filter, choke coil VIP access control
- Optional TFT Hand Terminal



EASY DRIVE ALAM 03

General Specifications

- Compatible EN81-20
- Assigned and programmable outputs Door opening leveling
- 1.6 m/s speed support and Ability to work up to 4 groups of lifts
- 16 standard stops
- Warning signal on LCD screen when the door is open or when no stop signal more than the adjusted time
- At revision mode selection of the movement to limit switches and exact floor level.



ARCODE

General Specifications

- Motor Control : Synchronic (gearless) Machine, Asynchronic (geared) Machine
- Elevator Speed (Maximum) : 4 m/s
- Number of stops : 64 Stops
- Automatic Bring to Floor : 1-Faz 220VAC UPS Accumulator Group Connection
- Drive Type : With or Without Machine Engine Room (MRL)
- Group Work Feature : Up to 8 elevators
- Serial Communication : With Ready Installation CANbus Serial Communication (standard)
- Encoder : Incremental Encoder (5V TTL or 10-30V HTL) Absolute Encoder (EnDat, SSI, SinCos or BISS)



ADRIVE

General Specifications

- Number of Stops : 24 Stops
- Drive Type : Double Speed, Hydraulic, VVVF
- Serial Communication : With cabin
- Cabin Position Information : Magnetic Switch
- Door Bridging : Available
- Programmable Input/Output : None
- Language Options : Turkish, English, Russian, Dutch, Romanian, German, Italian
- Control Type : Simple Control, One Way Pickup, Two Way Pickup
- Group Control : 4
- Elevator Speed (Maximum) : 1,6 m/s
- Automatic Door Control : Single Door, Double Door
- Display Outputs : 7 Segments, Gray/Binary Code Output
- Error Record : Up to 60 Faults
- Compliance to Standards : EN 81/1-2 + A3

ITALIANO 1

General Specifications

- Warning signal on LCD screen when the door is open for a long time or when the stop return circuit is not detected for a long time
- Electronic control of phases, phase order errors of these controls shown via LCD on board, turning off function by choosing the parameters, adjustable phase level sensitivity,
- At inspection mode the movement to limit switches or exact floor level can be chosen Short circuit protected display outputs can be adjusted to every floor.
- The function of manual movement at low speed by using program buttons.
- Cabin serial communication output.
- Supports up to 10 floors, options between an up or down collective
- One speed and two speed and vvvf controles





HOME LIFT



**ASCENDING
TOGETHER**

HYDRAULIC ELEVATOR PLATFORM ELEVATOR

At Alamex we present a new lifting solution for limited spaces, where the dimensions of some architectural space are not possible to place a conventional elevator, giving rise to the flexibility and easy installation of a home lift.

The great advantages of the home lift is that it optimizes the available spaces in new or existing buildings, having minimal electrical consumption, an avant-garde design and easy installation.



Minimum requirements in bucket depth and machine room.



Capacity from 200 to 5,000 Kg.



Maximum speed of 0.6 m / s



Manufactured in accordance with machinery directive 2006/42 / EC and EN-81.



Pre-assembled in rigid steel structure.



Available with platform, half cab, or full cab



DUPLEX VILLAS ELEVATOR



Easy and trouble-free installation in any area as it does not require a pit

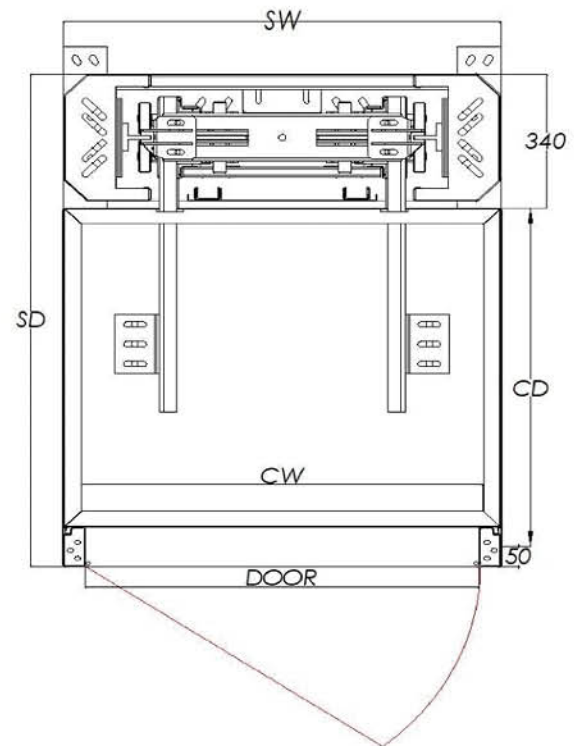

DOOR	SD	SW	PD	PW	N. OF PERSONS	CAPACITY
600 mm	990 mm	700 mm	600 mm	600 mm	1 Persons	150 kg
650 mm	1040 mm	750 mm	650 mm	650 mm	2 Persons	180 kg
700 mm	1090 mm	800 mm	700 mm	700 mm	2 Persons	220 kg
750 mm	1140 mm	850 mm	750 mm	750 mm	3 Persons	250 kg
800 mm	1190 mm	900 mm	800 mm	800 mm	3 Persons	300 kg
850 mm	1240 mm	950 mm	850 mm	850 mm	4 Persons	300 kg
900 mm	1290 mm	1000 mm	900 mm	900 mm	4 Persons	400 kg



TECHNICAL SPECIFICATIONS

DUPLEX VILLAS ELEVATOR

NUMBER OF STOPS	2 to 5.
TRAVEL DISTANCE	Maximum 15 meters (Max).
DRIVE SYSTEM	Hydraulic, Screw Column
MAXIMUM LOAD CAPACITY	Up to 400 kilograms.
TRAVEL SPEED	0.15 m/s.
PAINT	Options of Stainless Steel or specified color (RAL).
SAFETY EQUIPMENT	Parachute Brake.
DOOR	Glass, Painted RAL, Automatic or Manual
PIT DEPTH	Minimum 50 mm.
INTERCOM	Communication System.
Announcement System.	With Desired Language Option
EMERGENCY RESCUE SYSTEM	Backup system (UPS) for rescue, Manual Valve.
POWER OPTIONS	220-230 volts (Single Phase), 380-400 volts (Three Phase).



DUPLEX VILLAS ELEVATOR

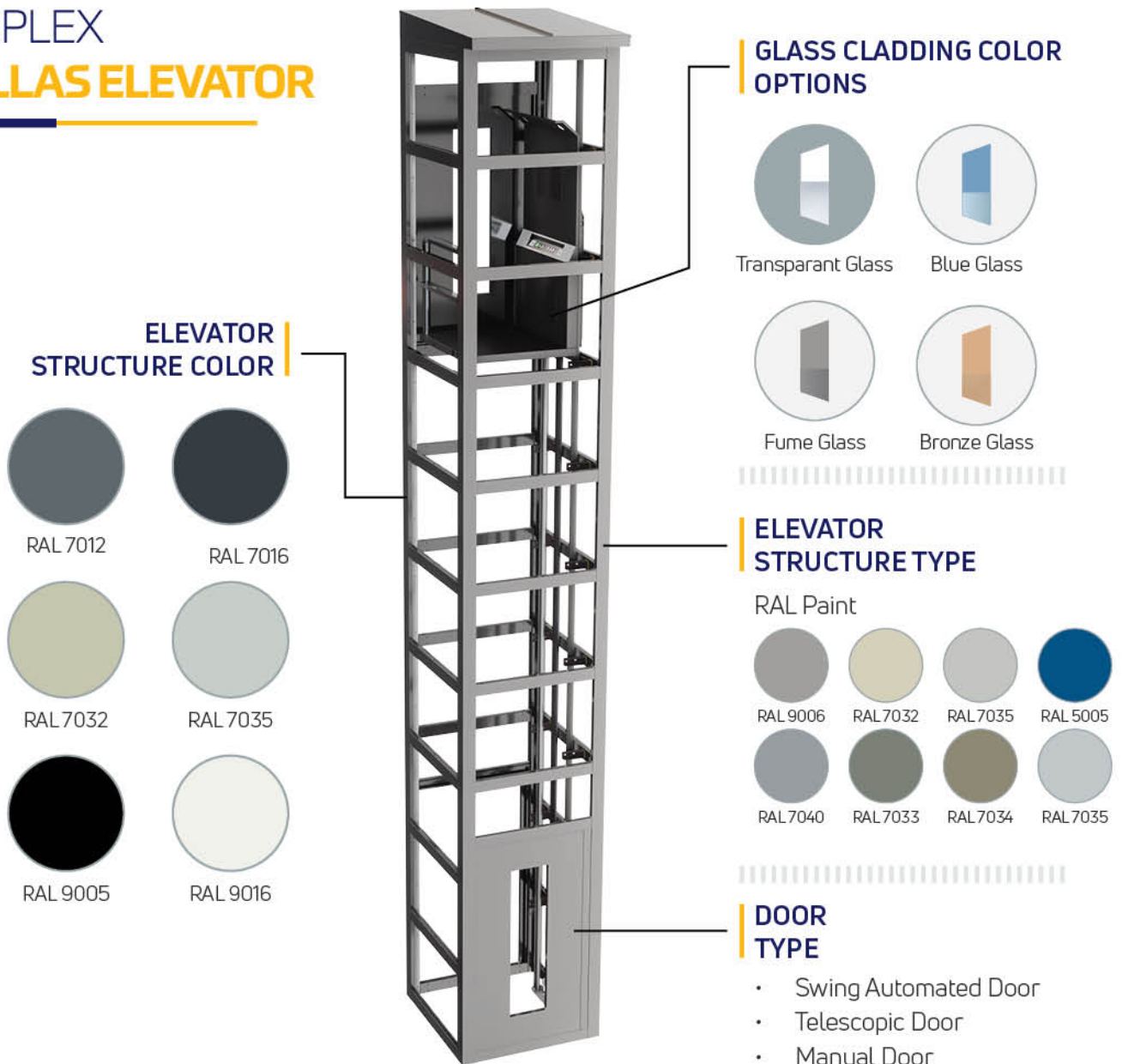

EXPLANATION

- It is a compact product
- Does not require significant structural changes in the location where it will be installed
- Your Home, Office etc. It can be installed anywhere.
- Thanks to sensitive sensors on the cabin floor and ceiling, it does not cause any narrowing in space
- When there is a power cut, it will automatically go down to the ground floor with the UPS system
- Voice announcement system notifies cabin movement



ENCLOSED TYPE PLATFORM (DISABLED) PLATFORM



Easy and trouble-free installation in any area as it does not require a pit

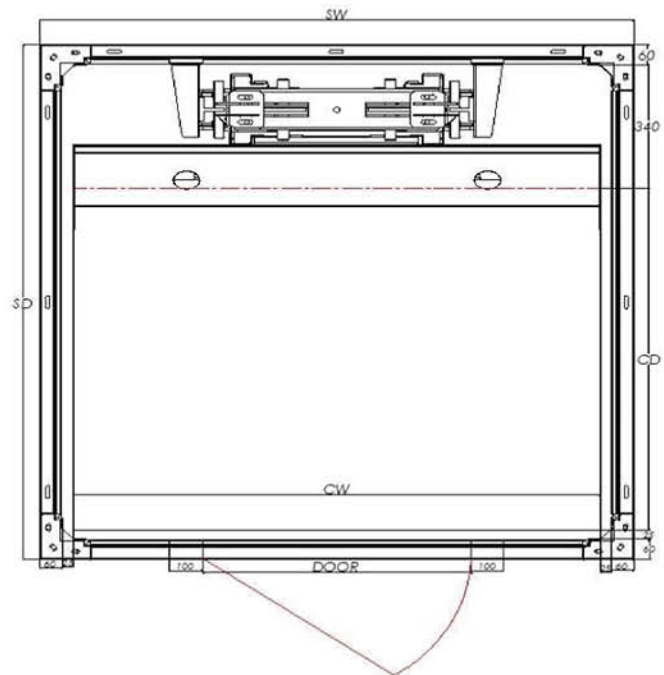

DOOR	SD	SW	PD	PW	N. OF PERSONS	CAPACITY
600 mm	1290 mm	970 mm	800 mm	800 mm	3 Persons	225 kg
700 mm	1390 mm	1070 mm	900 mm	900 mm	4 Persons	320 kg
800 mm	1490 mm	1170 mm	1000 mm	1000 mm	5 Persons	375 kg
900 mm	1590 mm	1270 mm	1100 mm	1100 mm	6 Persons	450 kg



TECHNICAL SPECIFICATIONS

DUPLEX VILLAS ELEVATOR







NUMBER OF STOPS	2 to 5 stops
TRAVEL DISTANCE	Maximum 15 meters.
TRACTION SYSTEM	Hydraulic, Screw
LOAD CAPACITY	Up to 500 kg
SPEED	0.15-0.30 m/s
COATING	Stainless steel/RAL colors option
SAFETY EQUIPMENT	Parachute Brake.
DOOR	Glass, RAL painted, semi-automatic, fully automatic
PIT DEPTH	Minimum 50 mm.
INTERCOM	Communication System.
VOICE ANNOUNCEMENT SYSTEM	With the option to select desired language, EMERGENCY RESCUE UPS System, Manual Valve.
EMERGENCY RESCUE SYSTEM	Backup system (UPS) for rescue, Manual Valve.
POWER OPTION	SINGLE PHASE 220-230 V THREE PHASE 380-400 V



ENCLOSED TYPE PLATFORM (DISABLED) PLATFORM











**ELEVATOR
STRUCTURE COLOR**





	
RAL 7012	RAL 7016
	
RAL 7032	RAL 7035
	
RAL 9005	RAL 9016

**ELEVATOR
STRUCTURE TYPE**

RAL Paint

			
RAL 9006	RAL 7032	RAL 7035	RAL 5005
			
RAL 7040	RAL 7033	RAL 7034	RAL 7035

**GLASS COLOR
OPTIONS**

	
Transparent Glass	Blue Glass
	
Fume Glass	Bronze Glass

**DOOR
TYPE**

- Swing Automated Door
- Telescopic Door
- Manual Door



EXPLANATION

- It has a wide place.
- It is produced in compliance with the regulations of 2006/42/AT and it is introduced into the market with CE mark.
- The traction system can be implemented using hydraulic technology or endless screw technology.
- It can be used safely indoors and outdoors.
- Thanks to not requiring a pit, it can be easily and smoothly installed in any area.
- No major structural changes are needed.
- It can be used in both open and closed spaces.
- It offers options for automatic and semi-automatic doors.



OPEN TYPE
DISABLED PLATFORM



User and environmental safety is kept at the highest Level

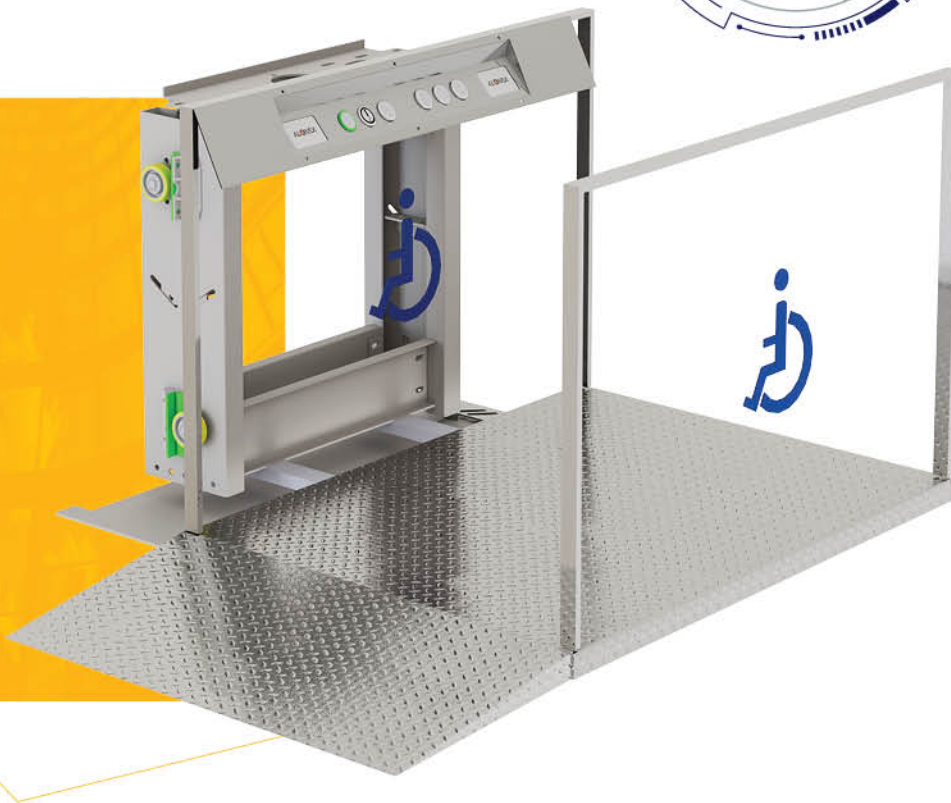
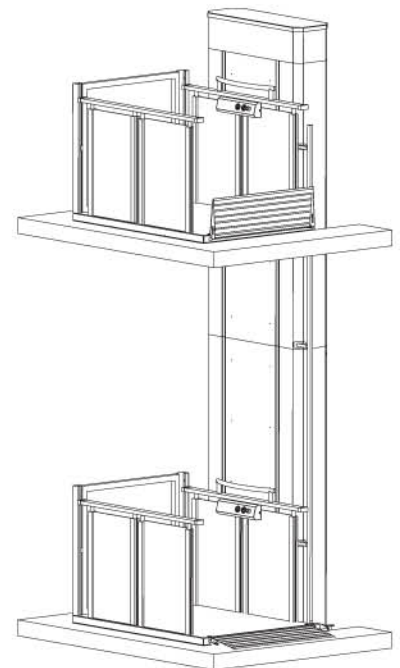
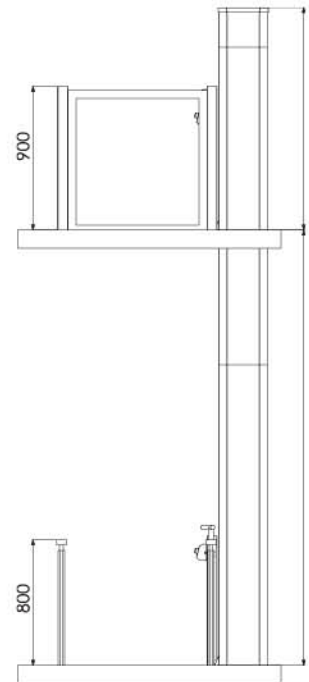

EXPLANATION

- It is a stylish model with double-sided carrier columns and attaches great importance to security.
- It can be used safely indoors and outdoors.
- Its outer coating consists of stainless material.
- Does not require a shaft.





TECHNICAL SPECIFICATIONS

DOOR	SD	SW	PD	PW	CAPACITY
800 mm	1200 mm	1290 mm	1200 mm	800 mm	300 kg
850 mm	1200 mm	1340 mm	1250 mm	850 mm	300 kg
900 mm	1400 mm	1540 mm	1300 mm	900 mm	300 kg

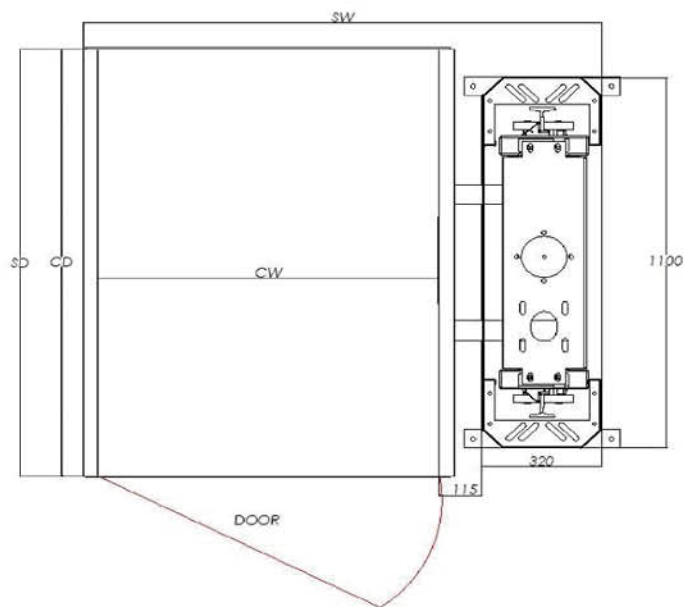

OPEN TYPE
DISABLED PLATFORM



**ELEVATOR
STRUCTURE COLOR**



RAL 7012



RAL 7016



RAL 7032



RAL 7035



RAL 9005



RAL 9016

**GLASS COLOR
OPTIONS**



Transparent Glass



Blue Glass



Fume Glass



Bronze Glass

**ELEVATOR
STRUCTURE TYPE**

RAL Paint

**DOOR
TYPE**

- Swing Automated Door
- Telescopic Door
- Manual Door

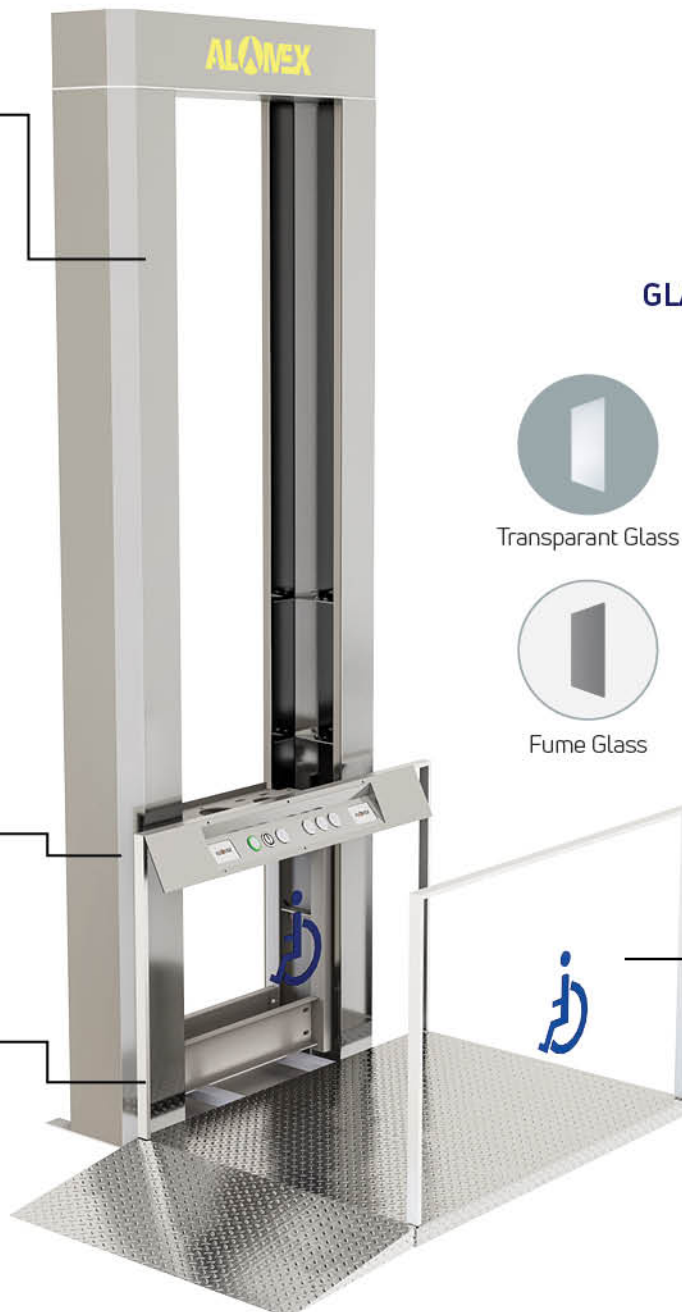

TRACTION ELEVATOR **SERVICE ELEVATOR**

It is a small service traction elevator with or without a machine room for small capacities.
It is suitable for service jobs such as libraries, restaurants, hotels, department stores or residential.

SERVICE ELEVATOR GUILLOTINE DOOR

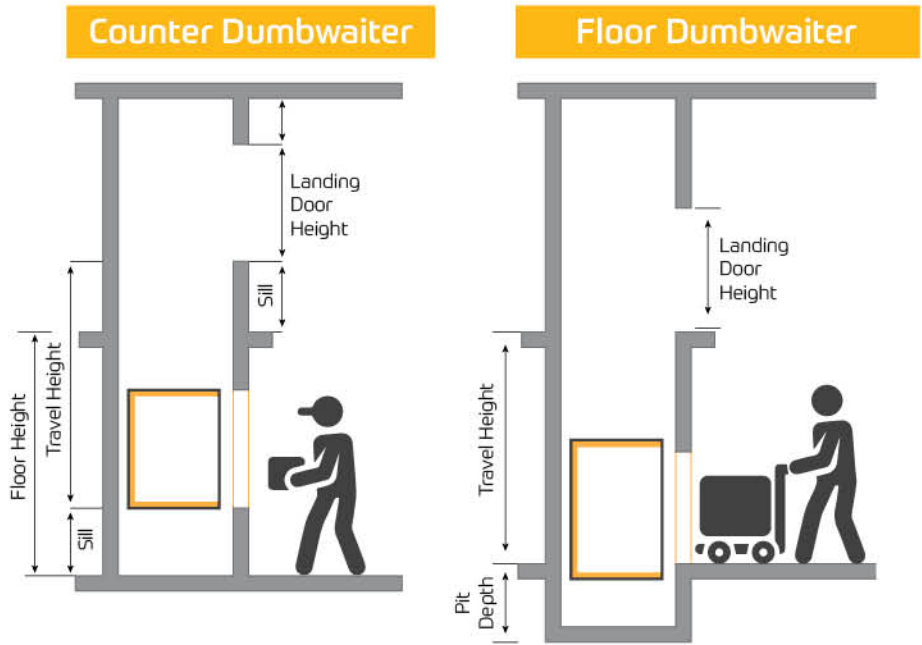

Manufactured in accordance with the machinery directive 2006/42 / EC and EN-81.



Capacity from 100 to 300 Kg.



Travel up to 30 meters (10-15 stops approximately).
Capacity: 300 Kg.



Smooth and quiet operation.
Quick and easy installation.



Minimum machine room space.
No need for a pit.

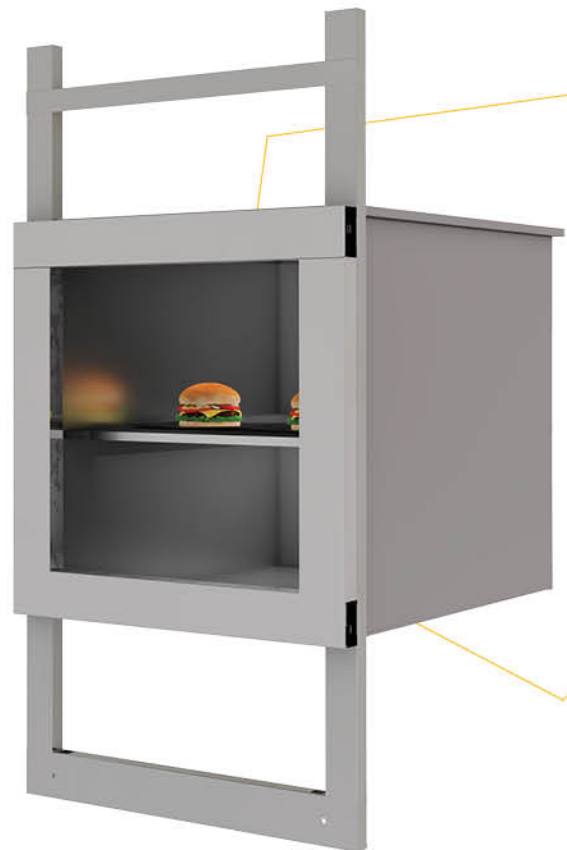

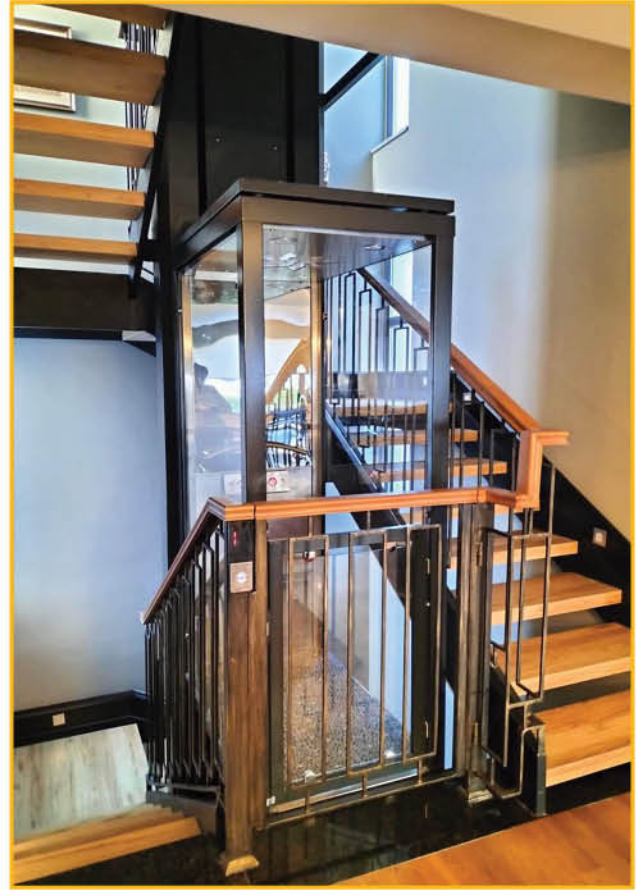

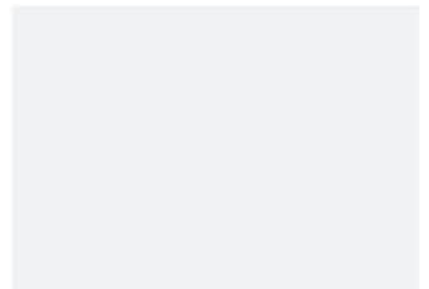
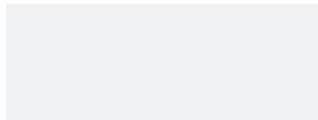
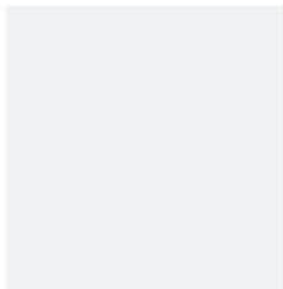
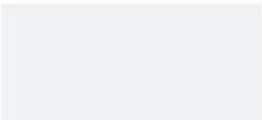
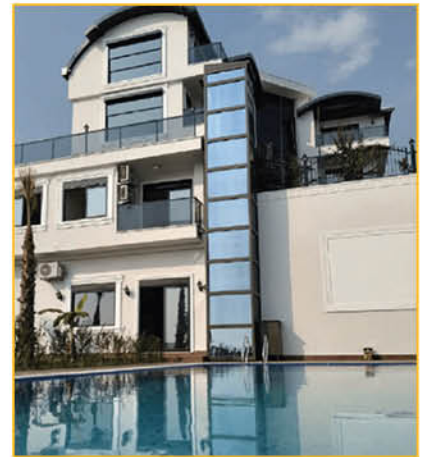
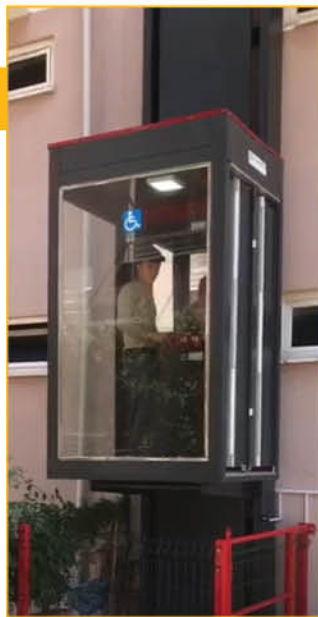
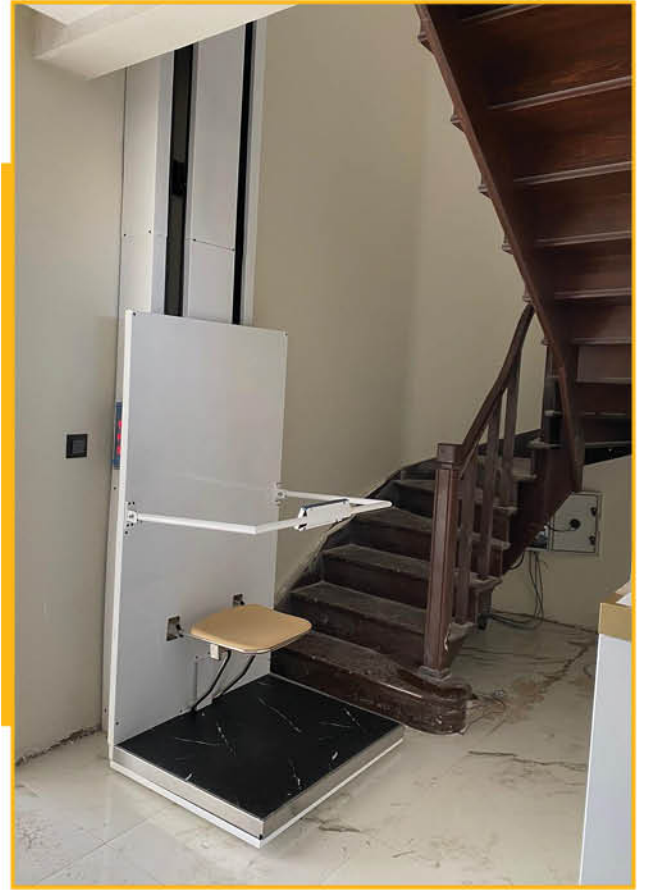

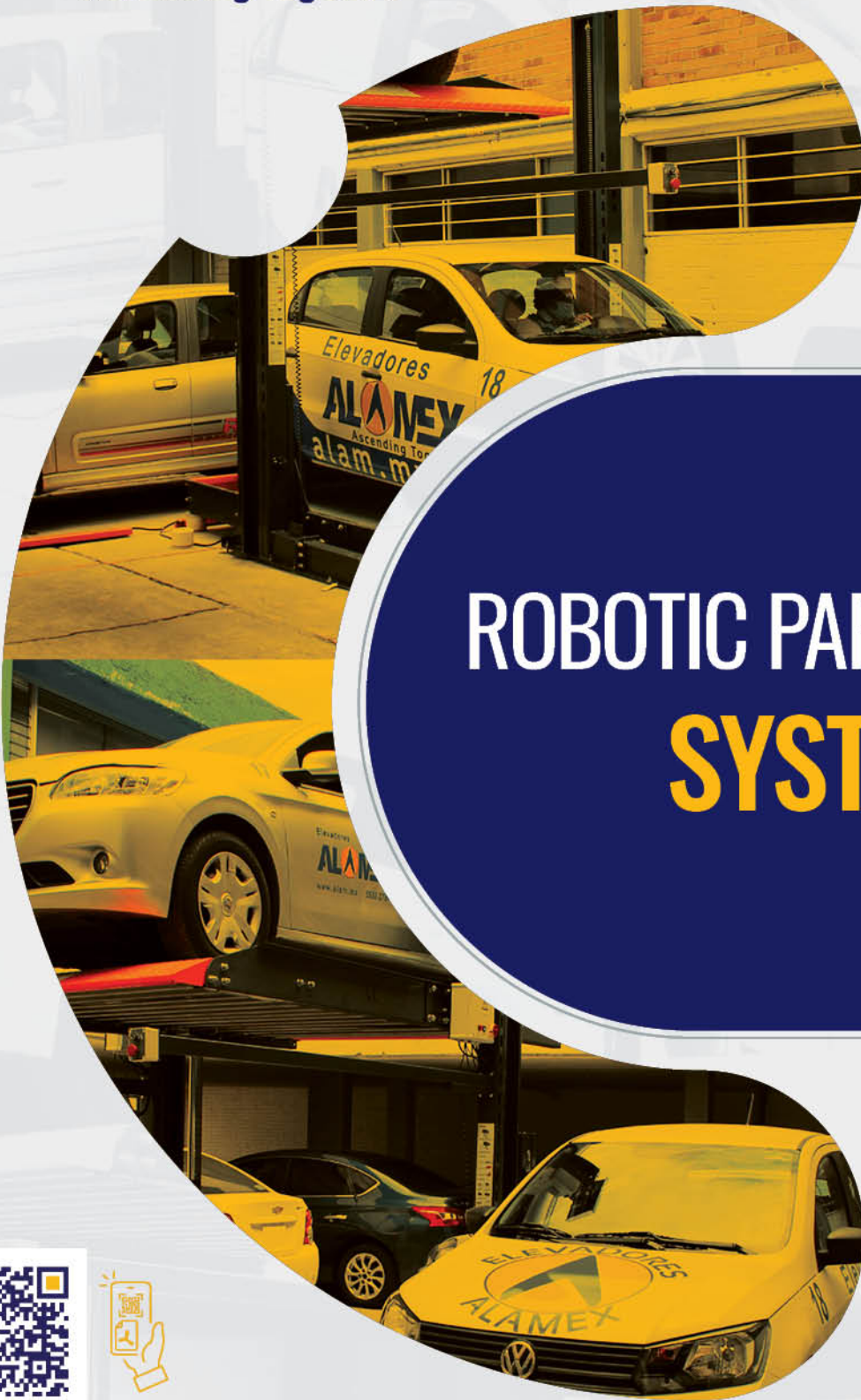

ROBOTIC PARKING SYSTEMS



ASCENDING
TOGETHER

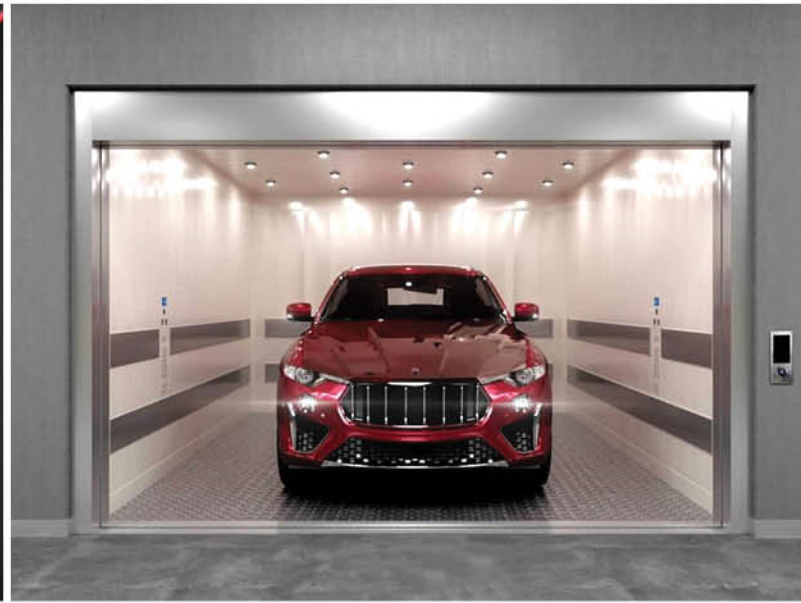
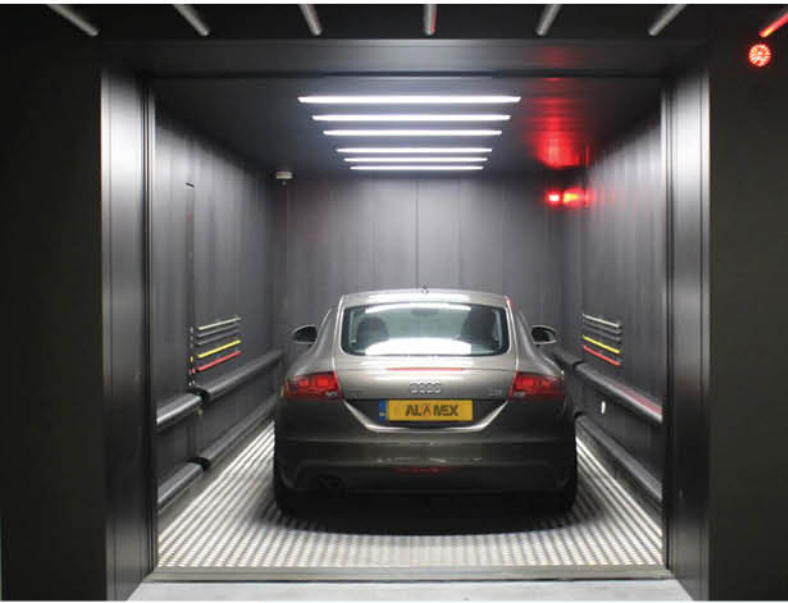

Alamex has joined the growing automatic parking systems market with the aim of providing complete automatic parking solutions, increasing parking possibilities and optimizing spaces.

CAR LIFT PLATFORM

Car lift platforms have cabins made of materials such as cold rolled steel or epoxy coating; used in accordance with the project design.

These car lift platforms can be used in industrial spaces, forklifts and / or tower parking lots.



Maximum load capacity of 5,000 Kg.
Maximum lifting speed of 6 cm / s.



4 meter travel.
Security mechanism.



Easy
installation.

CAR STACK

Car stacks are elevators whose main function is to park cars at different heights.

These types of elevators are very useful in buildings, homes, shopping centers or workshops that do not have sufficient parking spaces.

Alamex Car Stacks enable 2 or more cars to be parked in the area of a single car space by raising or lowering one vehicle so subsequent vehicles may be parked above or below it.

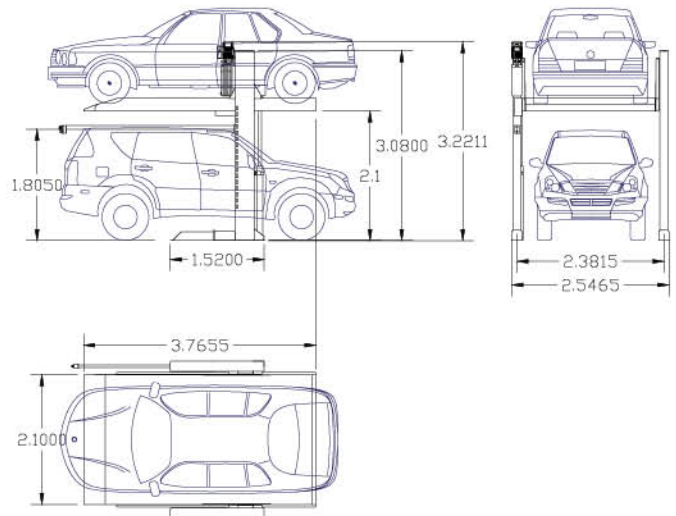

Type	1123	
Parking vehicels	2	
Single vehicels weight	2300kg	
Parking vehicels	2	
Size of car	Length	5000mm
	Width	1850mm
	Height	1550mm-2000m
Pump motor	2,2kw	
Lifting speed (seconds)	<55	
Electricity	380V 60 Hz 3 phases or 220V 60 Hz 2 phases	
Projection Mode		
Ratio	1:1	

AUTOMATED PARKING SYSTEM

It is a smart system aims at promoting maximum user comfort, reducing maneuvers and the space required for parking by increasing the parking space capacity.

It can be classified as an efficient anti-theft system, since it prevents the transit of people in the space where the vehicles are parked. There is a wide variety of systems, from the simplest with transfer and lifting platforms, to the most advanced fully robotized systems



Multiple parking spaces, using the maximum available height of the building.



Low installation cost. Minimal construction preparation.



Increase the parking space.



Security photocell option. Complete safety tray option.



Ideal for limited spaces.



Reduce pollution.



ESCALATOR & MOVING WALKWAYS



**ASCENDING
TOGETHER**



MOVING WALKWAYS

Alamex offers indoor and outdoor high- and low-traffic mobility systems.

Alamex moving sidewalks have smart modes of operation, which allow for economical operation and maintenance.

With the safety of users in mind, our moving sidewalks are made of non-slip materials. They have an exceptional aesthetic in the market, as well as led lighting to improve the design of projects.

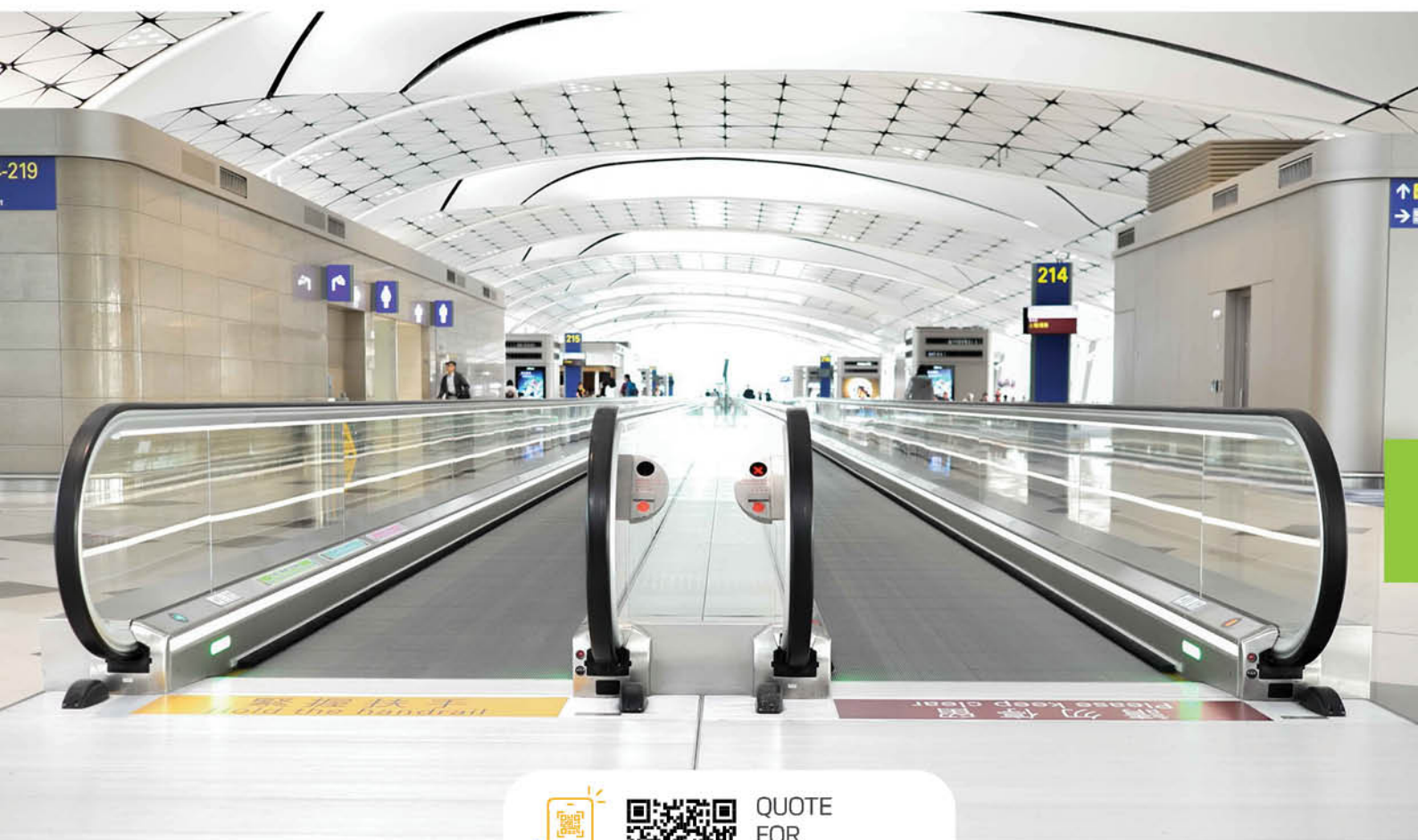

QUOTE
FOR
MOVING
WALKWAYS

ESCALATORS

We supply high-tech moving stairways and sidewalks that work in very demanding areas, with high demand and heavy traffic, such as airport terminals, metro stations and shopping centers.

These displacement systems are designed to provide comfort and safety to users. To make energy use more efficient and extend its life cycle, its design is manufactured to the EN - 115 quality standard that guarantees operation with minimal friction, vibration and noise.



QUOTE
FOR
ESCALATORS

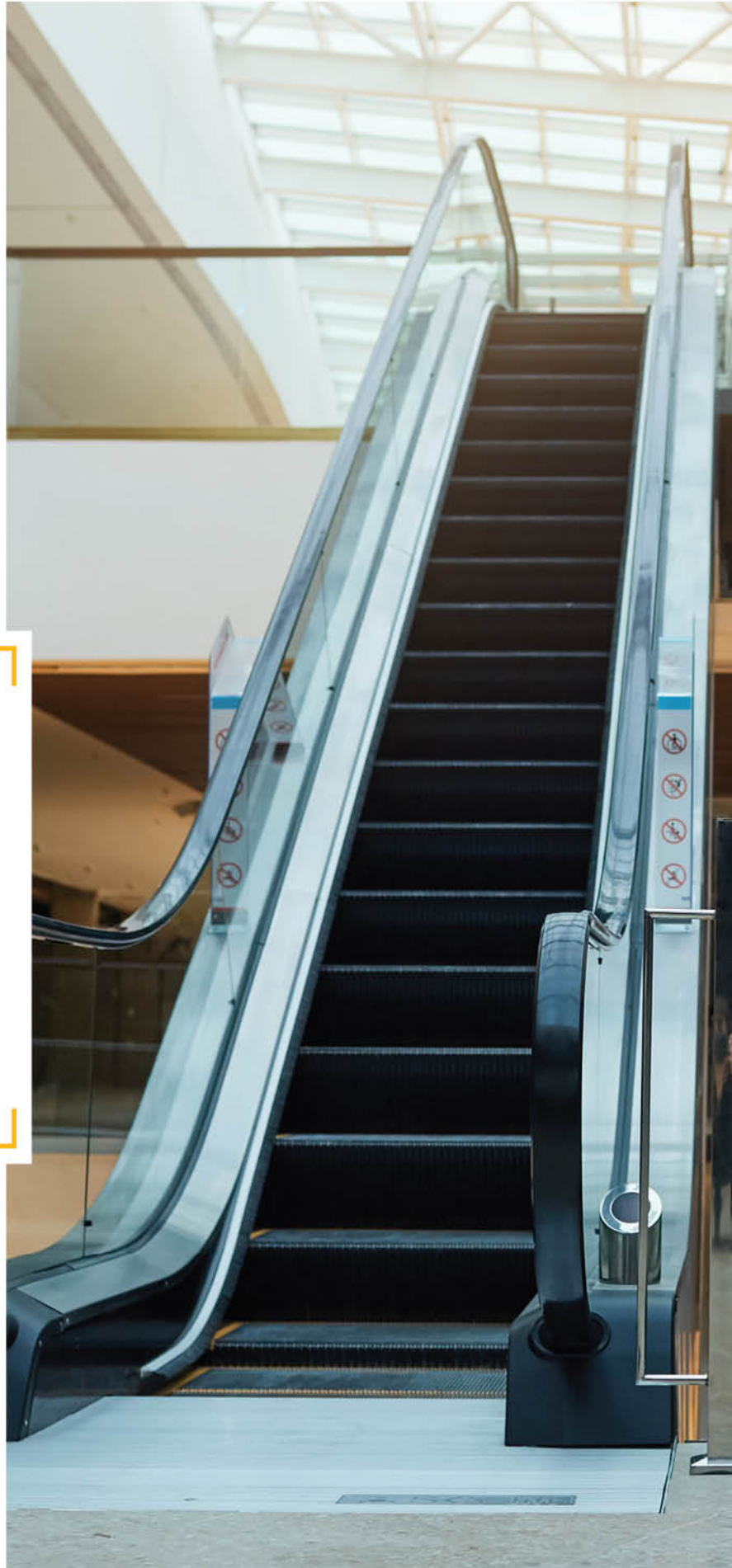

TOUCHLESS TECHNOLOGY

* Enter the QR code to learn more about Alamex Touchless technology



At Alamex we are aware that the way of interacting with other people and the environment is changing, that is why we offer solutions that care about the hygiene and well-being of everyone.

UVC STERILIZATION LAMP FOR HANDRAILS

Designed to completely eliminate bacteria and viruses on escalators and moving walks. Its function is peaceful and silent, allowing disinfection and purification in real time.

Ultraviolet light has a 99% sterilization rate, eliminating the transmission of viruses and bacteria.

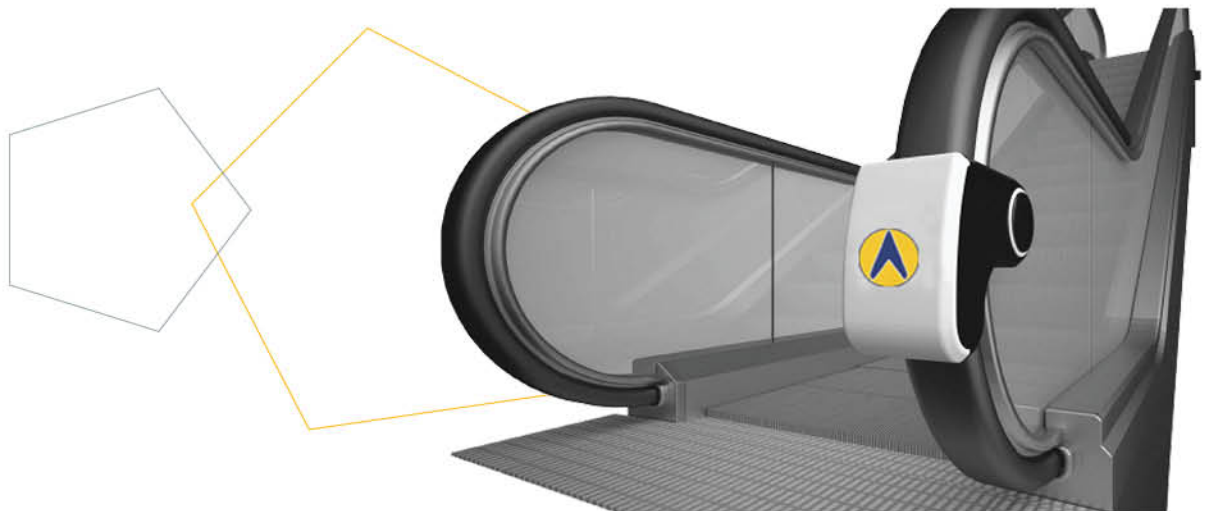

BENEFITS OF MODERNIZATION



Safety

At Alamex we make sure that the elevator complies with current safety regulations. In the elevator redesign process, we provide a wide range of safety options to ensure that the system is 100% safe.



Accessibility

Alamex cabins are durable and various. The elevator is guaranteed to meet the all types of needs and ensures better access for people with special needs.



Economic

Modernization provides long-term benefits. An elevator upgraded with new technology can operate in standby mode during idle intervals or with little traffic. For example, the cabin lighting and air fan automatically turn off when not in use, it also uses efficient LED lighting to minimize energy consumption.



Longer Lifespan

Travel quality is improved with smoother acceleration as well as quiet operation. These are the most important attributes that result from the modernization process. By placing the most technologically advanced components, Alamex is able to increase the lifespan of an elevator.





Elevator

ALOMEX

Ascending Together

WE PROVIDE QUALITY AND
SAFETY TO THE WORLD WITH OUR
FULL PACKAGE ELEVATORS SYSTEMS



alamxelevator    

Geared Traction Machines

Gearless Traction Machines



ALAMEX-T-SMART



ALAMEX-T-STRONG LITE



ALAMEX-QS-5



ALAMEX-QS-3



MONTANARI MR



ALAMEX-T-FORCE



ALBERTO SASSI G



SICOR SG



ALBERTO SASSI



SICOR MR



ZIEHL ABEGG ZATOP



ALAMEX-T-VOLPI



ALAMEX-T-ZF



ALAMEX-TVOLPI



MONTANARI MGV



ALAMEX-T-AK

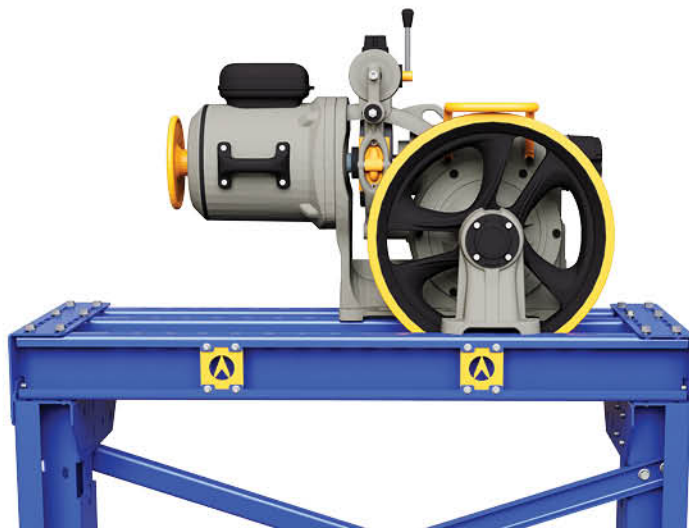



ELEVATOR | BUTTONS |



**ASCENDING
TOGETHER**





Speed Regulator



Bracket Set



Rops Attachment Flexible



Oiler



Oil Collector



Flexible Cable



Polyurethane Buffer



Counterweight Barite



Metal Guide Shoes



Elevator Control Card



Elevator Rails



Overload



Inverter Easy Drive

STANDARD WELL AND CABIN DIMENSIONS FOR CLASS I, II, III AND VI ELEVATORS

Declared load	Cabin Type	cabin dimensions			declared speed (m/s)	doors (full automatic)			counterweight position	shaft dimensions	
		width (b1)	depth (d1)	height (h4)		width (b2)	depth (h3)	Type		width (b3)	depth (d2)
1000 Kg	13 G1 single entrance	1600	1400	2350	1,00 1,6	900	2100	center	At the back	2020	2050
						1100			on the side	2300	1800
					1100			center	At the back	2400	2100
						on the side			2500	1800	
					1100	telescopic		At the back	2020	2150	
								on the side	2320	1850	
					1100	center		At the back	2400	2150	
	At the back	2150	2250								
	13 G2 single entrance	1750	1300	2350	1,00 1,60	900	2100	center	At the back	2200	1970
						1100				telescopic	2200
					1100			center		2400	1970
						900				telescopic	2200
					1100			center			At the back
						900				center	At the back
900					center			At the back			2400
	1,00 1,60 2,00 2,50 3,00 3,50 4,00 5,00 6,00	1100	2100	center		At the back	2470	2150			
1100					center	At the back	2500	2200			
						1100	center	At the back	2600	2300	
								1100	center	At the back	2400
1275 Kg	17 G single entrance	2000	1400	2400	1,00 1,60	2100	center	At the back	2470	2150	
									1100	center	2500
					1100		center				2600
									1100	center	At the back
	17 D single entrance	1200	2300	2400	1,00 1,60	2100	telescopic	on the side	2050	2750	
									1100	telescopic	At the back
					1100		telescopic				on the side
									1100	telescopic	At the back
1275 Kg	17 D double entrance	1200	2300	2400	1,00 1,60	2100	telescopic	on the side	2050	3000	
									1100	telescopic	on the side
					1100		telescopic				on the side
									1100	telescopic	on the side





STANDARD WELL AND CABIN DIMENSIONS FOR CLASS I, II, III AND VI ELEVATORS

Declared load	Cabin Type	cabin dimensions			declared speed (m/s)	doors (full automatic)			counterweight position	shaft dimensions	
		width (b1)	depth (d1)	height (h4)		width (b2)	depth (h3)	Type		width (b3)	depth (d2)
320 Kg	4 D single entrance	900	1000	2250	1,00 1,60	700	2000	telescopic	At the back	1400	1700
									on the side	1570	1450
450 Kg	6 D single entrance	1000	1250	2350	1,00 1,60	800	2100	telescopic	At the back	1550	1950
									on the side	1650	1700
						900		center	At the back	1800	1900
									on the side	1900	1650
telescopic	At the back	1700	1950								
	on the side	1700	1700								
630 Kg	8 D single entrance	1100	1400	2350	1,00 1,60	800	2100	telescopic	At the back	1600	2100
									on the side	1700	1820
						center		At the back	1800	2050	
								on the side	1800	1770	
						telescopic		At the back	1700	2100	
					on the side			1700	1820		
					center	At the back		2000	2050		
						on the side		200	1770		
					2,00 2,50	telescopic		At the back	1600	2100	
									1800	2050	
1700	2100										
2000	2050										
center	center	center									
800 Kg	10 D single entrance	1350	1400	2350	1,00 1,60	800	2100	center	At the back	1800	2070
									on the side	2100	1800
						telescopic		At the back	1770	2120	
								on the side	2050	1850	
						center		At the back	2000	2070	
					on the side			2200	1800		
					telescopic	At the back		1770	2120		
						on the side		2050	1850		
					2,00 2,50	center		At the back	1850	2150	
									1850	2200	
2020	2150										
1850	2200										
telescopic	telescopic	telescopic									
3,00 3,50	center	At the back	1900	2300							
			2100	2300							
			1700	2550							
			1800	2500							
			telescopic	telescopic	telescopic						
1000 Kg	13 D single entrance	1100	2100	2350	1,00 1,60	800	2100	telescopic	on the side	1700	2550
										1800	2500
					900	telescopic		1700		2550	
								2000		2500	
					telescopic	1750		2600			
						1900		2550			
					telescopic	1750		2600			
						2000		2550			
					800	telescopic		on the side		1950	2600
								center		At the back	1800
					900	telescopic		on the side		1950	2600
								center		At the back	2100
					4,00 5,00 6,00	telescopic		At the back		1850	2950
										1650	3000
2100	2950										
1750	3000										

Elevator systems
> we export to the World



ING SYSTEMS PROBOTIC PARKING SYS
ELEVATOR SYSTEMS
TECHNOLOGY ESCALATOR MOVING WALKWAYS TOUCHLESS TECHN
DOORS SPARE PARTS ACCESSORIES CABINS DOORS SPARE PARTS ACCESSORIES

20 YEARS

of experience

SYSTEMS ELEVATOR SYSTEMS PROBOTIC
TECHNOLOGY ESCALATOR MOVING WALKWAYS TOU
ACCESSORIES CABINS DOORS SPARE PARTS

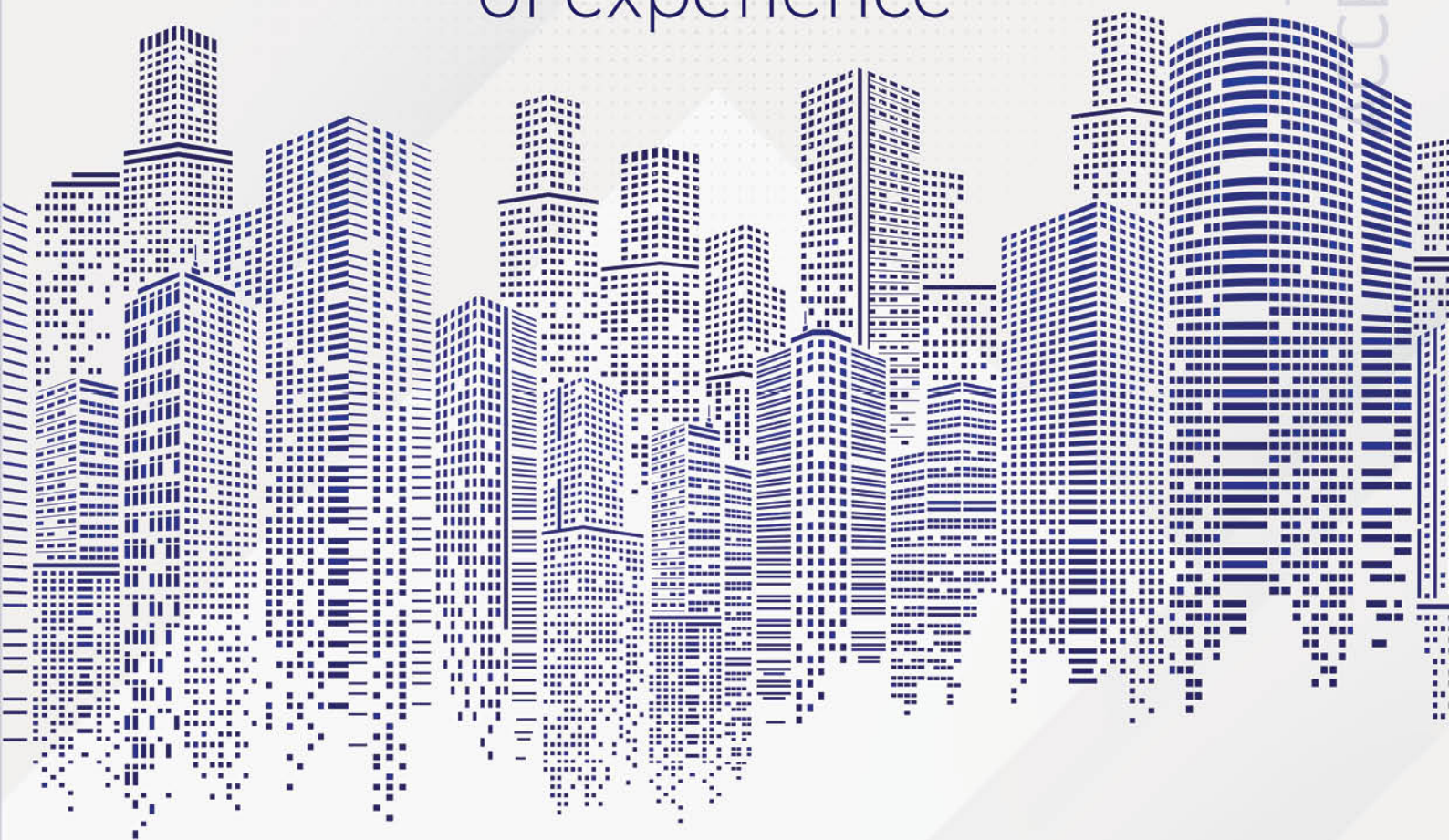

Elevator

ALAMEX

Ascending Together

ASCENDING
TOGETHER



ALAMEX ELEVADORES

- 219 Av. Tlahuac
CDMX CMX 09840 México
- +52 55 5532 2739
- +52 55 1952 18 57
- sales@alam.mx
- www.alam.mx



ALAMEX ELEVATOR

- Fevzi Çakmak Mah. İmsan Sanayi Sit.
Gülistan Cad. No:40/1 - 42050 Selçuklu/KONYA
- +90 (332)503 15 08
- 0090 0535 975 68 66
- info@alamex.com.tr
- www.alamex.com.tr

